

GLORIOUS[®]
MART
2023

GLORIOUS®



Firmamız 1994 yılında faaliyetine başlayıp toptan satış ve makine imalatçıların elektrik pano sistemlerinin kurulmasıyla hizmetine başlamıştır. Hedefimiz her zaman müşterilerimizin memnuniyeti için kaliteli malzemeler temin etmek ve en iyi hizmeti sunmak olmuştur. Globalleşen dünyada rekabet her alanda olduğu gibi sektörümüzde de hızla artmıştır.

Hızla büyüyen firmamız müşterilerimize daha iyi hizmet verebilmek için kaliteli elektrik malzeme imalatçılarına

1998 yılında işçilik ve üretim maliyetlerinin düşük olduğu üretim alanları arayışına girmiştir.

Avrupa da yüksek maliyetlerle üretilen elektrik malzemelerinin yerine Uzak doğunun düşük maliyet ve işçilik fırsatlarından yararlanıp kaliteli Çin firmaları ile işbirliği yaparak ve kaliteli üretim yapan GLORIOUS tescilli markamız

altında sağlam dayanaklı ve gerekli sertifikalara sahip

elektrik malzemelerini, asansör siviçleri üreterek Avrupa ülkeleri ile aynı kaliteyi yakaladı.

Kısa zamanda maliyetlerdeki fiyat avantajından ve kalitemizden dolayı sektörümüz için vazgeçilmez bir marka haline geldik.

Sektörümüzde 29 Senedir Bizi Destekleyen Tüm Firmalara Teşekkür Ederiz.

GLORIOUS®

»OTOMATİK SİGORTALAR
»KAÇAK AKIM RÖLELERİ

2

3



»TB5 SERİSİ BUTONLAR

24



»KONTAKTÖRLER
»TERMİK RÖLELER
»MOTOR KORUMA
»ŞALTERLERİ

4

9



»VİNÇ VE LİFT
»BUTON GRUPLARI

26



»ENDÜKTİF SİVİÇLER
»FOTOSELLER
»ZAMAN RÖLELERİ
»RÖLELER

10

12



»ASANSÖR REVİZYON
»BUTON KUTULARI VE
»TRİFAZE ŞALTERLER

27



»İKAZ LAMBALARI
»BUZZER VE SİRENLER

13

15



»PEDALLAR

28



»SİNYAL LAMBALARI
»AMPERMETRE
»VOLTMETRE

16



»AXIAL FANLAR

29



»C-A SERİSİ BUTONLAR

17

20



»SİVİÇLER
»ŞAMANDIRALAR

30

38



»LAY5 SERİSİ BUTONLAR
»BUTON KONTAKLARI

21

23



»KLEMENSLER
»DAĞITIM ÜNİTELERİ

40

43



»POTANSİYOMETRELER
»IŞIKLI ANAHTARLAR
»BUTON KILIFLARI
»BUTON MUHAFAZA

23



»KABLO YÜKSÜKLERİ
»KABLO UÇLARI

44

52





3SB1-63N 1 FAZLI OTOMATİK SİGORTALAR

Referans No	Akım / A	Kesme Kap. / A	Kutu / Koli	Birim Fiyatı (\$)
3SB1-63N C2	2A	6000	12/240	\$3,53
3SB1-63N C3	3A	6000	12/240	\$3,42
3SB1-63N C6	6A	6000	12/240	\$3,15
3SB1-63N C10	10A	6000	12/240	\$3,15
3SB1-63N C16	16A	6000	12/240	\$3,15
3SB1-63N C20	20A	6000	12/240	\$3,15
3SB1-63N C25	25A	6000	12/240	\$3,25
3SB1-63N C32	32A	6000	12/240	\$3,25
3SB1-63N C40	40A	6000	12/240	\$3,26
3SB1-63N C50	50A	4500	12/240	\$3,96
3SB1-63N C63	63A	4500	12/240	\$4,17



3SB1-63N 2 FAZLI OTOMATİK SİGORTALAR

Referans No	Akım / A	Kesme Kap. / A	Kutu / Koli	Birim Fiyatı (\$)
3SB1-63N C6	6A	6000	6/120	\$6,53
3SB1-63N C10	10A	6000	6/120	\$6,53
3SB1-63N C16	16A	6000	6/120	\$6,53
3SB1-63N C20	20A	6000	6/120	\$6,53
3SB1-63N C25	25A	6000	6/120	\$6,74
3SB1-63N C32	32A	6000	6/120	\$6,74
3SB1-63N C40	40A	6000	6/120	\$6,74
3SB1-63N C50	50A	4500	6/120	\$6,74
3SB1-63N C63	63A	4500	6/120	\$6,74



3SB1-63N 3 FAZLI OTOMATİK SİGORTALAR

Referans No	Akım / A	Kesme Kap. / A	Kutu / Koli	Birim Fiyatı (\$)
3SB1-63N C6	6A	6000	4/80	\$11,29
3SB1-63N C10	10A	6000	4/80	\$11,29
3SB1-63N C16	16A	6000	4/80	\$11,29
3SB1-63N C20	20A	6000	4/80	\$11,29
3SB1-63N C25	25A	6000	4/80	\$11,29
3SB1-63N C32	32A	6000	4/80	\$11,39
3SB1-63N C40	40A	6000	4/80	\$11,55
3SB1-63N C50	50A	4500	4/80	\$11,95
3SB1-63N C63	63A	4500	4/80	\$12,79



3SB1-63N 4 FAZLI OTOMATİK SİGORTALAR

Referans No	Akım / A	Kesme Kap. / A	Kutu / Koli	Birim Fiyatı (\$)
3SB1-63N C6	6A	6000	3/60	\$15,05
3SB1-63N C10	10A	6000	3/60	\$15,05
3SB1-63N C16	16A	6000	3/60	\$15,05
3SB1-63N C20	20A	6000	3/60	\$15,05
3SB1-63N C25	25A	6000	3/60	\$15,05
3SB1-63N C32	32A	6000	3/60	\$15,05
3SB1-63N C40	40A	6000	3/60	\$15,19
3SB1-63N C50	50A	4500	3/60	\$15,33
3SB1-63N C63	63A	4500	3/60	\$17,05



3SB1-125 3 FAZLI OTOMATİK SİGORTALAR

Referans No	Akım / A	Kesme Kap. / A	Kutu / Koli	Birim Fiyatı (\$)
3SB1-125 C 80	80A	10.000	2/20	\$36,27
3SB1-125 C100	100A	10.000	2/20	\$39,59
3SB1-125 C125	125A	10.000	2/20	\$50,93



2 KUTUPLU 30mA KAÇAK AKIM RÖLELERİ

Referans No	Akım / A	Kesme Kap. / A	Kutu / Koli	Birim Fiyatı (\$)
KL2-M 2P 20	20A	6000	1/50	\$21,79
KL2-M 2P 25	25A	6000	1/50	\$21,79
KL2-M 2P 32	32A	6000	1/50	\$21,79
KL2-M 2P 40	40A	6000	1/50	\$22,90
KL2-M 2P 50	50A	6000	1/50	\$23,43
KL2-M 2P 63	63A	6000	1/50	\$23,75



4 KUTUPLU 30mA KAÇAK AKIM RÖLELERİ

Referans No	Akım / A	Kesme Kap. / A	Kutu / Koli	Birim Fiyatı (\$)
KL2-M 4P 20	20A	6000	1/50	\$30,75
KL2-M 4P 25	25A	6000	1/50	\$30,75
KL2-M 4P 32	32A	6000	1/50	\$30,92
KL2-M 4P 40	40A	6000	1/50	\$31,25
KL2-M 4P 50	50A	6000	1/50	\$31,99
KL2-M 4P 63	63A	6000	1/50	\$32,31



DARBE AKIM RÖLESİ VE PTC'LI FAZ KORUMA

Referans No	Akım / A	Kutu / Koli	Birim Fiyatı (\$)
DR10	16A	12/120	\$16,95
RMP-01FP	-	-	\$19,97

3SC8 3 KUTUPLU KONTAKTÖRLER

Referans No	Anma Gücü / KW	Anma Akımı / A	AC 1 / A	Kontak No / Nc	Kutu / Koli	Birim Fiyatı (\$)
3SC8-0901	4	9	25	... 1	1/50	\$12,57
3SC8-0910	4	9	25	1 ...	1/50	\$12,57
3SC8-1201	5,5	12	25	... 1	1/50	\$14,55
3SC8-1210	5,5	12	25	1 ...	1/50	\$14,55
3SC8-1801	7,5	18	32	... 1	1/50	\$16,15
3SC8-1810	7,5	18	32	1 ...	1/50	\$16,15
3SC8-2501	11	25	40	... 1	1/50	\$22,99
3SC8-2510	11	25	40	1 ...	1/50	\$22,99
3SC8-3201	15	32	50	... 1	1/50	\$30,75
3SC8-3210	15	32	50	1 ...	1/50	\$30,75
3SC8-4011	18,5	40	60	1 1	1/20	\$51,90
3SC8-5011	22	50	80	1 1	1/20	\$56,18
3SC8-6511	30	65	80	1 1	1/20	\$63,67
3SC8-8011	37	80	125	1 1	1/16	\$84,53
3SC8-9511	45	95	125	1 1	1/16	\$90,95
3SC8-F115	55	115	200	1 1	1/4	\$187,25
3SC8-F150	75	150	250	1 1	1/4	\$201,15
3SC8-F185	90	185	275	1 1	1/4	\$268,57
3SC8-F225	110	225	315	1 1	1/2	\$288,90
3SC8-F265	132	265	350	1 1	1/2	\$315,65
3SC8-F330	160	330	400	1 1	1/2	\$557,47
3SC8-F400	200	400	500	1 1	1/2	\$583,15



3SC8 3 KUTUPLU KONTAKTÖRLER (24/42 VAC)

Referans No	Anma Gücü / KW	Anma Akımı / A	AC 1 / A	Kontak No / Nc	Kutu / Koli	Birim Fiyatı (\$)
3SC8-0901	4	9	25	... 1	1/50	\$13,85
3SC8-0910	4	9	25	1 ...	1/50	\$13,85
3SC8-1201	5,5	12	25	... 1	1/50	\$16,35
3SC8-1210	5,5	12	25	1 ...	1/50	\$16,35
3SC8-1801	7,5	18	32	... 1	1/50	\$17,76
3SC8-1810	7,5	18	32	1 ...	1/50	\$17,76
3SC8-2501	11	25	40	... 1	1/50	\$25,29
3SC8-2510	11	25	40	1 ...	1/50	\$25,29
3SC8-3201	15	32	50	... 1	1/50	\$33,82
3SC8-3210	15	32	50	1 ...	1/50	\$33,82
3SC8-4011	18,5	40	60	1 1	1/20	\$57,10
3SC8-5011	22	50	80	1 1	1/20	\$61,80
3SC8-6511	30	65	80	1 1	1/20	\$70,05
3SC8-8011	37	80	125	1 1	1/16	\$92,95
3SC8-9511	45	95	125	1 1	1/16	\$99,95





SC 3 KUTUPLU KONTAKTÖRLER

Referans No	Anma Gücü / KW	Anma Akımı / A	AC 1 / A	Kontak No / Nc	Kutu / Koli	Birim Fiyatı (\$)
SC-0901	4	9	25	... 1	1/50	\$10,69
SC-0910	4	9	25	1 ...	1/50	\$10,69
SC-1201	5,5	12	25	... 1	1/50	\$10,97
SC-1210	5,5	12	25	1 ...	1/50	\$10,97
SC-1801	7,5	18	32	... 1	1/50	\$12,93
SC-1810	7,5	18	32	1 ...	1/50	\$12,93
SC-2501	11	25	40	... 1	1/50	\$18,28
SC-2510	11	25	40	1 ...	1/50	\$18,28
SC-3201	15	32	50	... 1	1/50	\$24,19
SC-3210	15	32	50	1 ...	1/50	\$24,19



SC 3 KUTUPLU KONTAKTÖRLER (24/42 VAC)

Referans No	Anma Gücü / KW	Anma Akımı / A	AC 1 / A	Kontak No / Nc	Kutu / Koli	Birim Fiyatı (\$)
SC-0901	4	9	25	... 1	1/50	\$11,76
SC-0910	4	9	25	1 ...	1/50	\$11,76
SC-1201	5,5	12	25	... 1	1/50	\$12,07
SC-1210	5,5	12	25	1 ...	1/50	\$12,07
SC-1801	7,5	18	32	... 1	1/50	\$14,22
SC-1810	7,5	18	32	1 ...	1/50	\$14,22
SC-2501	11	25	40	... 1	1/50	\$20,10
SC-2510	11	25	40	1 ...	1/50	\$20,10
SC-3201	15	32	50	... 1	1/50	\$26,60
SC-3210	15	32	50	1 ...	1/50	\$26,60



JR28 TERMİK RÖLELER

Referans No	Termik Ayar Sahası / A	Birlikte Kullanılacağı Kontaktör Referansı	Kutu / Koli	Birim Fiyatı (\$)
JR28-D1303	0,25...0,4	3SC8-09...32	1/100	\$11,95
JR28-D1304	0,4...0,63	3SC8-09...32	1/100	\$11,95
JR28-D1305	0,63...1	3SC8-09...32	1/100	\$11,95
JR28-D1306	1...1,6	3SC8-09...32	1/100	\$11,95
JR28-D1307	1,6...2,5	3SC8-09...32	1/100	\$11,95
JR28-D1308	2,5...4	3SC8-09...32	1/100	\$11,95
JR28-D1310	4...6	3SC8-09...32	1/100	\$11,95
JR28-D1312	5,5...8	3SC8-09...32	1/100	\$11,95
JR28-D1314	7...10	3SC8-09...32	1/100	\$11,95
JR28-D1316	9...13	3SC8-09...32	1/100	\$11,95
JR28-D1321	12...18	3SC8-09...32	1/100	\$11,95
JR28-D1322	17...25	3SC8-09...32	1/100	\$11,95
JR28-D2353	23...32	3SC8-25...32	1/50	\$23,40
JR28-D2355	28...36	3SC8-25...32	1/50	\$23,40
JR28-D3353	23...32	3SC8-40...95	1/50	\$27,50
JR28-D3355	30...40	3SC8-40...95	1/50	\$27,50
JR28-D3357	37...50	3SC8-40...95	1/50	\$27,50
JR28-D3359	48...65	3SC8-40...95	1/50	\$27,50
JR28-D3361	55...70	3SC8-40...95	1/50	\$27,50
JR28-D3363	63...80	3SC8-40...95	1/50	\$27,50
JR28-D3365	80...93	3SC8-40...95	1/50	\$27,50



DZ518 MOTOR KORUMA RÖLELERİ

Referans No	Güç / KW	Ayar Sahası / A	Kutu / Koli	Birim Fiyatı (\$)
DZ518-2-M01		0,1-0,16	1/50	\$31,97
DZ518-2-M02		0,15-0,25	1/50	\$31,97
DZ518-2-M03		0,25-0,4	1/50	\$31,97
DZ518-2-M04		0,4-0,63	1/50	\$31,97
DZ518-2-M05		0,63-1,0	1/50	\$31,97
DZ518-2-M06	0,37	1,0-1,6	1/50	\$31,97
DZ518-2-M07	0,75	1,6-2,5	1/50	\$31,97
DZ518-2-M08	1,5	2,5-4,0	1/50	\$31,97
DZ518-2-M10	2,2	4,0-6,3	1/50	\$31,97
DZ518-2-M14	4	6--10	1/50	\$31,97
DZ518-2-M16	5,5	9--14	1/50	\$31,97
DZ518-2-M20	7,5	13-18	1/50	\$31,97
DZ518-2-M21	11	17-23	1/50	\$31,97
DZ518-2-M22	11	20-25	1/50	\$31,97
DZ518-2-M32	15	24-32	1/50	\$37,55



DZ518-2-AN11

DZ518-2-AE11

DZ518 MOTOR KORUMA RÖLESİ YARDIMCI KONTAK

Referans No	Termik Ayar Sahası / A	Kutu / Koli	Birim Fiyatı (\$)
DZ518-2-AE11	1No + 1Nc	10/300	\$4,97
DZ518-2-AE20	2No	10/300	\$4,97
DZ518-2-AN11	1No + 1Nc	10/300	\$6,80
DZ518-2-AN20	2No	10/300	\$6,80



DZ518 MOTOR KORUMA RÖLESİ BOŞ KUTU

Referans No	Açıklama	Kutu / Koli	Birim Fiyatı (\$)
DZ518-4	Plastik Kutu	1/50	\$15,75

3SQ1 MOTOR YOL VERİCİLER KONTAKTÖR TERMİKLİ

Referans No	Kontaktör Amp	Güç / KW	Termik Ayar Sahası / A	Kutu / Koli	Birim Fiyatı (\$)
3SQ1-09D1305	9	0,37	0,63-1	1/16	\$45,54
3SQ1-09D1306	9	0,55	1-1,6	1/16	\$45,54
3SQ1-09D1307	9	1,1	1,6-2,5	1/16	\$45,54
3SQ1-09D1308	9	1,5	2,5-4	1/16	\$45,54
3SQ1-09D1310	9	2,2	4-6	1/16	\$45,54
3SQ1-12D1312	12	3	5,5-8	1/16	\$46,64
3SQ1-12D1314	12	4	7-10	1/16	\$46,64
3SQ1-18D1314	18	5,5	7-10	1/16	\$48,24
3SQ1-18D1316	18	7,5	9-13	1/16	\$48,24
3SQ1-18D1321	18	7,5	12-18	1/16	\$48,24
3SQ1-25D1321	25	11	12-18	1/16	\$60,50
3SQ1-25D1322	25	11	17-25	1/16	\$60,50
3SQ1-32D1322	32	15	17-25	1/16	\$60,50





CHX2 3 KUTUPLU KONTAKTÖRLER

Referans No	Anma Gücü / KW	Anma Akımı / A	AC 1 / A	Kontak No / Nc	Kutu / Koli	Birim Fiyatı (\$)
CHX2-0911	4	9	25	1 1	1/50	\$14,85
CHX2-1211	5,5	12	25	1 1	1/50	\$15,57
CHX2-1811	7,5	18	32	1 1	1/50	\$18,16
CHX2-2511	11	25	40	1 1	1/50	\$24,90
CHX2-3211	15	32	50	1 1	1/50	\$38,37
CHX2-4011	18,5	40	60	1 1	1/20	\$58,85
CHX2-5011	22	50	80	1 1	1/20	\$70,60
CHX2-6511	30	65	80	1 1	1/20	\$87,08
CHX2-8011	37	80	125	1 1	1/20	\$129,46
CHX2-9511	45	95	125	1 1	1/20	\$138,45

CHX2 3 KUTUPLU KONTAKTÖRLER (24/42 VAC)

Referans No	Anma Gücü / KW	Anma Akımı / A	AC 1 / A	Kontak No / Nc	Kutu / Koli	Birim Fiyatı (\$)
CHX2-0911	4	9	25	1 1	1/50	\$16,35
CHX2-1211	5,5	12	25	1 1	1/50	\$17,15
CHX2-1811	7,5	18	32	1 1	1/50	\$19,95
CHX2-2511	11	25	40	1 1	1/50	\$27,40
CHX2-3211	15	32	50	1 1	1/50	\$42,20
CHX2-4011	18,5	40	60	1 1	1/20	\$64,45
CHX2-5011	22	50	80	1 1	1/20	\$77,65
CHX2-6511	30	65	80	1 1	1/20	\$95,80
CHX2-8011	37	80	125	1 1	1/20	\$142,40
CHX2-9511	45	95	125	1 1	1/20	\$152,30



CHX2 YARDIMCI KONTAK BLOKLARI

Referans No	Kontak Düzeni	Kutu / Koli	Birim Fiyatı (\$)
CHX2-F4-11	1Nc-1No	1/400	\$4,30
CHX2-F4-22	2No-2Nc	1/300	\$7,10



3SC7 KUTUPLU KONTAKTÖRLER

Referans No	Anma Gücü / KW	Anma Akımı / A	AC 1 / A	Kontak No / Nc	Kutu / Koli	Birim Fiyatı (\$)
3SC7-F40-22	4	9	20	2 2	1/50	\$16,17
3SC7-F42-22	7,5	16	30	2 2	1/50	\$23,10
3SC7-F43-22	10	22	30	2 2	1/50	\$24,25
3SC7-F44-22	15	32	55	2 2	1/30	\$38,32
3SC7-F45-22	18,5	38	55	2 2	1/30	\$39,90
3SC7-F47	30	63	80	2 2	1/16	\$65,10

JR28-59 TERMİK RÖLELER

Referans No	Termik Ayar Sahası / A	Kutu / Koli	Birim Fiyatı (\$)
JR28-59 1	0,63-1	1/75	\$18,73
JR28-59 1,6	1-1,6	1/75	\$18,73
JR28-59 2,5	1,6-2,5	1/75	\$18,73
JR28-59 4	2,5-4	1/75	\$18,73
JR28-59 6,3	4-6,3	1/75	\$18,73
JR28-59 10	6,3-10	1/75	\$18,73
JR28-59 16	10-16	1/75	\$18,73
JR28-59 25	16-25	1/75	\$20,87
JR28-59 40	25-40	1/75	\$20,87
JR28-59 57	40-57	1/75	\$20,87





3SC8 - K MİNİ KONTAKTÖRLER

Referans No	Anma Gücü / KW	Anma Akımı / A	AC 1 / A	Kontak No / Nc	Kutu / Koli	Birim Fiyatı (\$)
3SC8-K0901	4	9	16	... 1	1/100	\$12,55
3SC8-K0910	4	9	16	1 ...	1/100	\$12,55
3SC8-K1201	5,5	12	20	... 1	1/100	\$12,95
3SC8-K1210	5,5	12	20	1 ...	1/100	\$12,95



3SC8 - K MİNİ KONTAKTÖRLER (24VDC)

Referans No	Anma Gücü / KW	Anma Akımı / A	AC 1 / A	Kontak No / Nc	Kutu / Koli	Birim Fiyatı (\$)
UKD1-9M 24V	4	9	25	1 ...	1/100	\$25,95



DÖRT KUTUPLU KONTAKTÖRLER (SESSİZ) 4P

Referans No	Anma Akım / Amper	AC 1 / A	Kontak No / Nc	Kutu / Koli	Birim Fiyatı (\$)
3SCH8-25.4P4No	25A	25A	4No	1/50	\$31,50
3SCH8-25.4P4No	63A	63A	4No	1/50	\$41,70



3SC8 JENERATÖR ŞEBEKE KONTAKTÖRLERİ

Referans No	Anma Akım / Amper	AC 1 / A	Kontak No / Nc	Kutu / Koli	Birim Fiyatı (\$)
3SC8-12008	12	25	2+2	1/50	\$15,87
3SC8-25008	25	40	2+2	1/50	\$29,45
3SC8-40008	40	60	2+2	1/50	\$69,62
3SC8-65008	65	80	2+2	1/50	\$87,58



3SC8 YARDIMCI KONTAK BLOKLARI

Referans No	Kontak Düzeni	Kutu / Koli	Birim Fiyatı (\$)
3SC8-A1-11	1Nc-1No	1/250	\$3,95
3SC8-A1-20	2No	1/250	\$3,95
3SC8-A1-02	2Nc	1/250	\$3,95
3SC8-A1-22	2No-2Nc	1/250	\$6,75
3SC8-A1-04	4Nc	1/250	\$6,75
3SC8-A1-40	4No	1/250	\$6,75



KONTAKTÖRLER İÇİN YEDEK BOBİNLER

Referans No	Kontak Düzeni	Gerilim (Volt)	Kutu / Koli	Birim Fiyatı (\$)
3SC8X-D2	3SC8-09..18	24,110,220,380	1	\$5,65
3SC8X-D4	3SC8-25..32	24,110,220,380	1	\$6,42
3SC8X-D6	3SC8-40..95	24,110,220,380	1	\$6,61
3SC8X-FF	3SC8-115..150	24,110,220,380	1	\$51,36
3SC8X-FG	3SC8-185..225	24,110,220,380	1	\$72,81
3SC8X-FH	3SC8-265..330	24,110,220,380	1	\$100,85
3SC8X-FJ	3SC8-F400	24,110,220,380	1	\$179,28
3SC8X-FK	3SC8-F500	24,110,220,380	1	\$309,98
3SC8X-FL	3SC8-F630	24,110,220,380	1	\$337,69



CKC1 KONTAKTÖR SERİSİ

Referans No	Anma Akım / Amper	AC 1 / A	Kontak No / Nc	Kutu / Koli	Birim Fiyatı (\$)
CKC1-09	9	25	1+1	1/60	\$14,00
CKC1-12	12	25	1+1	1/60	\$14,00
CKC1-18	18	32	1+1	1/60	\$18,80
CKC1-22	22	40	1+1	1/60	\$19,50
CKC1-32	32	50	2+2	1/40	\$32,75
CKC1-40	40	60	2+2	1/40	\$33,75
CKC1-50	50	80	2+2	1/20	\$61,87
CKC1-65	65	80	2+2	1/20	\$63,00
CKC1-75	75	100	2+2	1/20	\$85,00
CKC1-85	85	110	2+2	1/20	\$88,00



CKC1 KONTAKTÖR YARDIMCI KONTAK BLOKLARI

Referans No	Kontak Düzeni	Kutu / Koli	Birim Fiyatı (\$)
AU-1	1No+1Nc	1/250	\$4,49
AU-2 1NO+1NC	1No+1Nc	1/250	\$4,87
AU-4 2NO+2NC	2No+2Nc	1/250	\$8,24



CKH TERMİK RÖLELER

Referans No	Termik Ayar Sahası / A	Birlikte Kullanılacağı Kontaktör Referansı	Kutu / Koli	Birim Fiyatı (\$)
CKH-22	0,63...1	CKC(1) 9....22 (A)	1/100	\$14,37
CKH-22	1...1,6	CKC(1) 9....22 (A)	1/100	\$14,37
CKH-22	1,6...2,5	CKC(1) 9....22 (A)	1/100	\$14,37
CKH-22	2,5...4	CKC(1) 9....22 (A)	1/100	\$14,37
CKH-22	4...6	CKC(1) 9....22 (A)	1/100	\$14,37
CKH-22	5...8	CKC(1) 9....22 (A)	1/100	\$14,37
CKH-22	7...10	CKC(1) 9....22 (A)	1/100	\$14,37
CKH-22	9...13	CKC(1) 9....22 (A)	1/100	\$14,37
CKH-22	12...18	CKC(1) 9....22 (A)	1/100	\$14,37
CKH-22	16...22	CKC(1) 9....22 (A)	1/100	\$14,37
CKH-40	18...26	CKC(1) 32....40 (A)	1/100	\$16,43
CKH-40	24...36	CKC(1) 32....40 (A)	1/100	\$16,43
CKH-40	28...40	CKC(1) 32....40 (A)	1/50	\$16,43

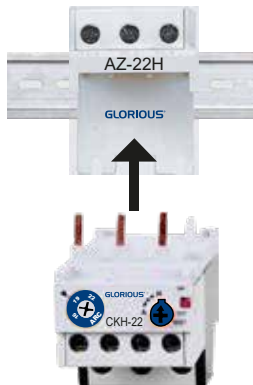

CKH-22 TERMİK RÖLE AYIĞI

Referans No	Açıklama	Kutu / Koli	Birim Fiyatı (\$)
AZ-22H	CKH-22 TERMİK RÖLE AYIĞI	1/250	\$3,97



LM8 ENDÜKTİF SİVİÇ

Referans No	Açıklama	Kutu / Koli	Birim Fiyatı (\$)
LM8-3002NA	6-36 VDC 3 MM NPN NO	20/300	\$20,76
LM8-3002NB	6-36 VDC 3 MM NPN NC	20/300	\$20,76
LM8-3002PA	6-36 VDC 3 MM PNP NO	20/300	\$20,76
LM8-3002PB	6-36 VDC 3 MM PNP NC	20/300	\$20,76



LM12 ENDÜKTİF SİVİÇ

Referans No	Açıklama	Kutu / Koli	Birim Fiyatı (\$)
LM12-2005A	90-250 VAC 5 MM NO	10/300	\$18,03
LM12-2005B	90-250 VAC 5 MM NC	10/300	\$18,03
LM12-3005NA	6-36 VDC 5 MM NPN NO	10/300	\$18,03
LM12-3005NB	6-36 VDC 5 MM NPN NC	10/300	\$18,03
LM12-3005NC	6-36 VDC 5 MM NPN NO+NC	10/300	\$22,68
LM12-3005PA	6-36 VDC 5 MM PNP NO	10/300	\$20,22
LM12-3005PB	6-36 VDC 5 MM PNP NC	10/300	\$20,22
LM12-3005PC	6-36 VDC 5 MM PNP NO+NC	10/300	\$22,68



LM18 ENDÜKTİF SİVİÇ

Referans No	Açıklama	Kutu / Koli	Birim Fiyatı (\$)
LM18-2005A	90-250 VAC 5 MM NO	8/240	\$20,22
LM18-2005B	90-250 VAC 5 MM NC	8/240	\$20,22
LM18-3005NA	6-36 VDC 5 MM NPN NO	8/240	\$20,22
LM18-3005NB	6-36 VDC 5 MM NPN NC	8/240	\$20,22
LM18-3005NC	6-36 VDC 5 MM NPN NO+NC	8/240	\$22,68
LM18-3005PA	6-36 VDC 5 MM PNP NO	8/240	\$20,22
LM18-3005PB	6-36 VDC 5 MM PNP NC	8/240	\$20,22
LM18-3005PC	6-36 VDC 5 MM PNP NO+NC	8/240	\$22,68



CİSİMDEN YANSIMALI 10 CM FOTOSEL

Referans No	Açıklama	Kutu / Koli	Birim Fiyatı (\$)
G18-3A10NA	FOTOSEL 10-30 VDC NPN NO	8/240	\$31,08
G18-3A10NB	FOTOSEL 10-30 VDC NPN NC	8/240	\$31,08
G18-3A10NC	FOTOSEL 10-30 VDC NPN NO+NC	8/240	\$31,08
G18-3A10PA	FOTOSEL 10-30 VDC PNP NO	8/240	\$31,08
G18-3A10PB	FOTOSEL 10-30 VDC PNP NC	8/240	\$31,08
G18-3A10PC	FOTOSEL 10-30 VDC PNP NO+NC	8/240	\$31,08
G18-2A10LA	FOTOSEL 90-220 VAC NO	8/240	\$34,02
G18-2A10LB	FOTOSEL 90-220 VAC NC	8/240	\$34,02

CİSİMDEN YANSIMALI 40 CM FOTOSEL

Referans No	Açıklama	Kutu / Koli	Birim Fiyatı (\$)
G18-3A40NA	FOTOSEL 10-30 VDC NPN NO	8/240	\$31,08
G18-3A40NB	FOTOSEL 10-30 VDC NPN NC	8/240	\$31,08
G18-3A40NC	FOTOSEL 10-30 VDC NPN NO+NC	8/240	\$31,08
G18-3A40PA	FOTOSEL 10-30 VDC PNP NO	8/240	\$31,08
G18-3A40PB	FOTOSEL 10-30 VDC PNP NC	8/240	\$31,08
G18-3A40PC	FOTOSEL 10-30 VDC PNP NO+NC	8/240	\$31,08
G18-2A40LA	FOTOSEL 90-220 VAC NO	8/240	\$34,02
G18-2A40LB	FOTOSEL 90-220 VAC NC	8/240	\$34,02



REFLEKTÖR YANSIMALI 2M FOTOSEL

Referans No	Açıklama	Kutu / Koli	Birim Fiyatı (\$)
G18-3B2NA	FOTOSEL 10-30 VDC NPN NO	8/240	\$35,47
G18-3B2NB	FOTOSEL 10-30 VDC NPN NC	8/240	\$35,47
G18-3B2NC	FOTOSEL 10-30 VDC NPN NO+NC	8/240	\$35,47
G18-3B2PA	FOTOSEL 10-30 VDC PNP NO	8/240	\$35,47
G18-3B2PB	FOTOSEL 10-30 VDC PNP NC	8/240	\$35,47
G18-3B2PC	FOTOSEL 10-30 VDC PNP NO+NC	8/240	\$35,47
G18-2B2LA	FOTOSEL 90-220 VAC NO	8/240	\$39,27
G18-2B2LB	FOTOSEL 90-220 VAC NC	8/240	\$39,27

ZAMAN RÖLELERİ

Referans No	Açıklama	Kutu / Koli	Birim Fiyatı (\$)
ST3PA-B 24 ACV	6 Sn.....6 Dk. 24 VAC 8 Pin	10/100	\$14,02
ST3PA-B 220 ACV	6 Sn.....6 Dk. 220 VAC 8 Pin	10/100	\$14,02
AYKA-DH 48S	Dijital-24-220V AC-DC 0,01 Sn...99H	1/100	\$54,68



DH48S



ST3PA

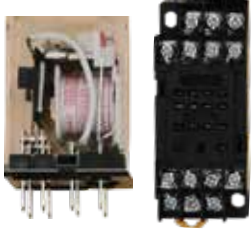

MY RÖLELER

Referans No	Açıklama	Kutu / Koli	Birim Fiyatı (\$)
MY2-24 VAC	2 Kontaklı - 8 Pin	50/500	\$6,15
MY2-220 VAC	2 Kontaklı - 8 Pin	50/500	\$6,15
MY2-24 VDC	2 Kontaklı - 8 Pin	50/500	\$6,15
MY4-24 VAC	4 Kontaklı - 14 Pin	50/500	\$6,35
MY4-220 VAC	4 Kontaklı - 14 Pin	50/500	\$6,35
MY4-24 VDC	4 Kontaklı - 14 Pin	50/500	\$6,35
PYF - 08A	Soket 8 Pinli Röle MY2 İçin	20/400	\$4,55
PYF - 14	Soket 14 Pinli Röle MY4 İçin	20/400	\$4,95



60.2 ve 60.3 RÖLELER

Referans No	Açıklama	Kutu / Koli	Birim Fiyatı (\$)
60.02-24VAC	2 Kontaklı - 8 Pin	20/200	\$9,54
60.02-220VAC	2 Kontaklı - 8 Pin	20/200	\$9,54
60.02-24VDC	2 Kontaklı - 8 Pin	20/200	\$9,54
60.03-24VAC	3 Kontaklı - 11 Pin	20/200	\$9,72
60.03-220VAC	3 Kontaklı - 11 Pin	20/200	\$9,72
60.03-24VDC	3 Kontaklı - 11 Pin	20/200	\$9,72
PYF - 13A	Soket 8 Pinli Röle 60.2 İçin	20/400	\$4,39
PYF - 15A 9023	Soket 11 Pinli Röle 60.3 İçin	20/400	\$4,70



JQX-14FC RÖLELER

Referans No	Açıklama	Kutu / Koli	Birim Fiyatı (\$)
JQX-14FC1Z-24VDC	1 Kontaklı - 5 Pin	100/500	\$4,83
JQX-14FC2Z-24VDC	2 Kontaklı - 8 Pin	100/500	\$5,46
JQX-14FC2Z-220VAC	2 Kontaklı - 8 Pin	100/500	\$8,71
PSF-08A	Soket 5 Pinli Röle JQX-14FC1Z İçin	20/400	\$4,79
PSF-14A	Soket 8 Pinli Röle JQX-14FC2Z İçin	20/400	\$5,05



1 KUTUPLU SOLID STATE RÖLELER (SSR)

Referans No	Giriş VDC	Giriş VAC	Amper / A	Kutu / Koli	Birim Fiyatı (\$)
SSR-25DA	3-32VDC	24-380	25	10/150	\$17,67
SSR-40DA	3-32VDC	24-380	40	10/200	\$22,69
SSR-50DA	3-32VDC	90-480	50	10/200	\$30,78
SSR-60DA	3-32VDC	90-480	60	10/150	\$33,63
SSR-70DA	3-32VDC	90-480	70	10/150	\$42,75
SSR-80DA	3-32VDC	90-480	80	10/150	\$45,03



SAYICILAR

Referans No	Açıklama	Kutu / Koli	Birim Fiyatı (\$)
CSK-6NKW-220V	6 Haneli Mekanik Sayıcı	1/100	\$27,95
CSK-6NKW-24V	6 Haneli Mekanik Sayıcı	1/100	\$27,95



KÖPRÜ DİYOTLAR

Referans No	Açıklama	Kutu / Koli	Birim Fiyatı (\$)
KBPC 35A 1000V	Köprü Diyot 35A	100/1000	\$1,65
KBPC 50A 1000V	Köprü Diyot 50A	100/1000	\$2,79
KBPC 35A 1000V A Class	Köprü Diyot 35A	100/1000	\$3,37
KBPC 50A 1000V A Class	Köprü Diyot 50A	100/1000	\$5,47



Referans No : G-5111
 Açıklama : Ledli İkaz Lambası
 Gerilim : 220VAC / 24VDC
 Renk : 
 Kutu / Koli : 1/30
 Fiyat : \$29,75

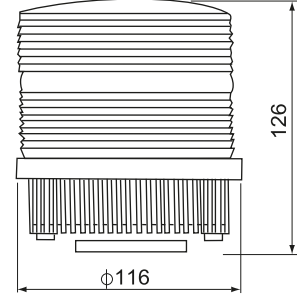

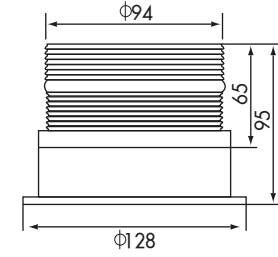

Referans No : C-5095
 Açıklama : Ledli İkaz Lambası
 Gerilim : 220VAC / 24VDC
 Renk : 
 Kutu / Koli : 1/30
 Fiyat : \$25



Multi Color



3 Renk Bir Arada

Referans No : N ROG-U + BUZZER 
 Açıklama : Ledli 3 Renk Bir Arada İkaz Lambası
 Gerilim : 24VDC
 Led Renkleri : 
 Kutu / Koli : 1/30
 Fiyat : \$30,95

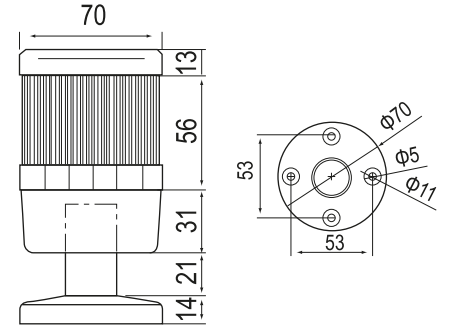

Referans No : NLT-70
 Açıklama : Ledli İkaz Lambası
 Gerilim : 220VAC / 24VDC
 Renk : 
 Fiyat : \$27,70

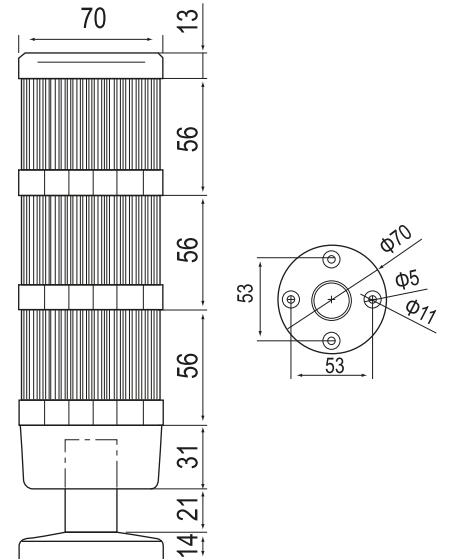

Referans No : FZ-S-2.55
 Açıklama : Ayak ve Kapak
 Fiyat : \$12,82



Referans No : NLT70JC (I)
 Açıklama : BUZZER 
 Fiyat : \$16,84





Referans No : N-1081

Referans No : **N-1081J + BUZZER** 

Açıklama : Ledli İkaz Lambası

Gerilim : 220VAC / 24VDC / 24VDC-220VAC

Renk : 

Kutu / Koli : 1/32

Fiyat : \$29,50 / \$30,55 / **\$33,75**

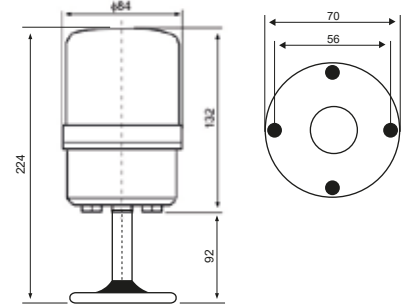

Referans No : N-1082

Referans No : **N-1082J + BUZZER** 

Açıklama : Ledli İkaz Lambası

Gerilim : 220VAC / 24VDC

Renk : 

Kutu / Koli : 1/32

Fiyat : \$29,50 / \$30,55 / **\$33,75**

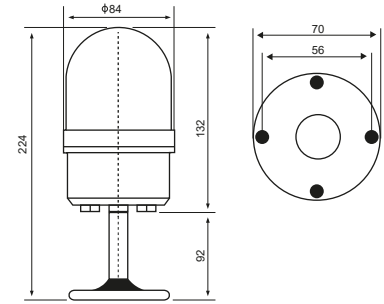

Referans No : C-1101

Referans No : **C-1101J + BUZZER** 

Açıklama : Ledli İkaz Lambası

Gerilim : 220VAC / 24VDC / 24VDC-220VAC

Renk : 

Kutu / Koli : 1/30

Fiyat : \$28,44 / \$29,58 / **\$33,95**

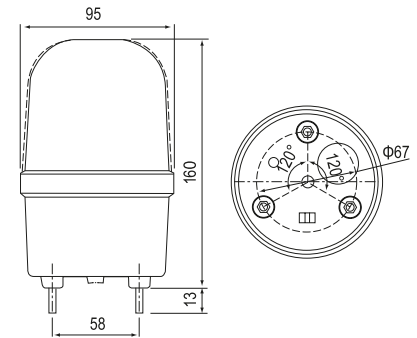

Referans No : LTE-2071

Referans No : **LTE-2071J + BUZZER** 

Açıklama : Ledli İkaz Lambası

Gerilim : 220VAC / 24VDC

Renk : 

Kutu / Koli : 1/60

Fiyat : \$25,08 / **\$26,22**

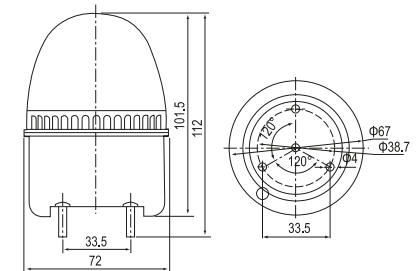

Referans No : C-3072

Referans No : **C-3072J + BUZZER** 

Açıklama : Ledli İkaz Lambası

Gerilim : 220VAC / 24VDC

Renk : 

Kutu / Koli : 1/80

Fiyat : \$25,08 / **\$26,22**

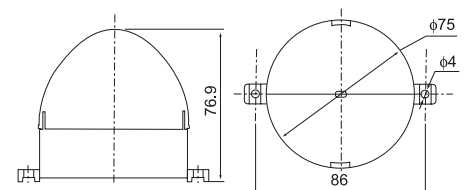



Referans No : AD22-22M/r
 Açıklama : Buzzer Ledli (🔔)
 Gerilim : AC 220V / AC DC 24V
 Kutu / Koli : 10/500
 Fiyat : \$2,95



Referans No : AD22-22-MK
 Açıklama : Buzzer (🔔)
 Gerilim : AC 220V / AC DC 24V
 Kutu / Koli : 10/500
 Fiyat : \$2,50



Referans No : C-F1-PS101A
 Açıklama : Buzzer (🔔)
 Gerilim : DCV12 / DCV24 / ACV220
 Kutu / Koli : 1/30
 Fiyat : \$6,95 / \$6,95 / \$7,45



Referans No : 1201-BUZ
 Açıklama : Buzzer (🔔)
 Gerilim : DCV24 & DCV12
 Kutu / Koli : 1/100
 Fiyat : \$7,95



Referans No : ES60
 Açıklama : Buzzer (🔔)
 Gerilim : DCV12
 Kutu / Koli : 10/500
 Fiyat : \$7,70



Referans No : CF
 Açıklama : Buzzer (🔔)
 Gerilim : ACV220
 Kutu / Koli : 1/100
 Fiyat : \$6,00



Referans No : MS190
 Açıklama : Motorlu Siren
 Gerilim : ACV220 & DCV24
 Kutu / Koli : 1/40
 Fiyat : \$15,75 / \$16,95

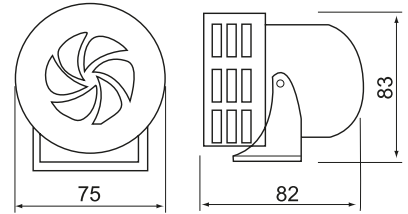

Referans No : MS290
 Açıklama : Motorlu Siren
 Gerilim : ACV220 & DCV24
 Kutu / Koli : 1/24
 Fiyat : \$25,50

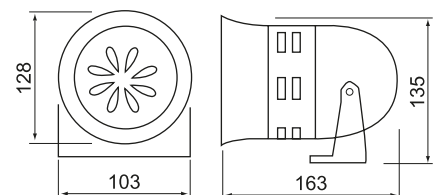

22mm SİNYAL LAMBALARI



Referans No	Renk	Gerilim	Çap	Kutu / Koli	Birim Fiyatı (\$)
AD22-22R	Kırmızı	220V	22 mm	10/500	\$0,85
AD22-22G	Yeşil	220V	22 mm	10/500	\$0,85
AD22-22Y	Sarı	220V	22 mm	10/500	\$0,85
AD22-22B	Mavi	220V	22 mm	10/500	\$0,95
AD22-22W	Beyaz	220V	22 mm	10/500	\$0,95
AD22-22R	Kırmızı	24V	22 mm	10/500	\$0,85
AD22-22G	Yeşil	24V	22 mm	10/500	\$0,85
AD22-22Y	Sarı	24V	22 mm	10/500	\$0,85
AD22-22B	Mavi	24V	22 mm	10/500	\$0,95
AD22-22W	Beyaz	24V	22 mm	10/500	\$0,95

16mm SİNYAL LAMBALARI



Referans No	Renk	Gerilim	Çap	Kutu / Koli	Birim Fiyatı (\$)
AD22-16R	Kırmızı	220V	16 mm	10/500	\$1,45
AD22-16G	Yeşil	220V	16 mm	10/500	\$1,45
AD22-16Y	Sarı	220V	16 mm	10/500	\$1,45
AD22-16B	Mavi	220V	16 mm	10/500	\$1,45
AD22-16W	Beyaz	220V	16 mm	10/500	\$1,45
AD22-16R	Kırmızı	24V	16 mm	10/500	\$1,45
AD22-16G	Yeşil	24V	16 mm	10/500	\$1,45
AD22-16Y	Sarı	24V	16 mm	10/500	\$1,45
AD22-16B	Mavi	24V	16 mm	10/500	\$1,45
AD22-16W	Beyaz	24V	16 mm	10/500	\$1,45

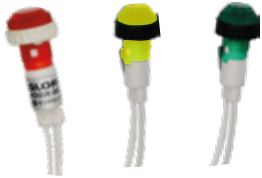

10mm SİNYAL LAMBALARI

Referans No	Renk	Gerilim	Çap	Kutu / Koli	Birim Fiyatı (\$)
AD22E-005R	Kırmızı	220V	10 mm	100/2500	\$0,67
AD22E-005G	Yeşil	220V	10 mm	100/2500	\$0,67
AD22E-005Y	Sarı	220V	10 mm	100/2500	\$0,67



AMPERMETRE - VOLTMETRE 22mm

Referans No	Renk	Gerilim	Çap	Kutu / Koli	Birim Fiyatı (\$)
AD22-22R	Kırmızı	220V	22 mm	10/200	\$10,95
AD22-22G	Yeşil	220V	22 mm	10/200	\$10,95
AD22-22Y	Sarı	220V	22 mm	10/200	\$10,95



VOLTMETRE 22mm (Büyük Haneli)

Referans No	Renk	Gerilim	Çap	Kutu / Koli	Birim Fiyatı (\$)
AD22-22R	Kırmızı	220V	22 mm	10/500	\$4,17
AD22-22G	Yeşil	220V	22 mm	10/500	\$4,17
AD22-22Y	Sarı	220V	22 mm	10/500	\$4,17



Yaylı Buton



Referans No	Renk	Gerilim	Çap	Kutu / Koli	Birim Fiyatı (₺)
C-A-01	Kırmızı	220V	22 mm	10/200	₺ 39,75
C-A-10	Yeşil	220V	22 mm	10/200	₺ 39,75
C-A-11	Sarı	220V	22 mm	10/200	₺ 39,75
C-A-21	Mavi	220V	22 mm	10/200	₺ 39,75
C-A-31	Beyaz	220V	22 mm	10/200	₺ 39,75
C-A-41	Siyah	220V	22 mm	10/200	₺ 39,75

Kalıcı Buton



Referans No	Renk	Gerilim	Çap	Kutu / Koli	Birim Fiyatı (₺)
C-A-01T	Kırmızı	220V	22 mm	10/200	₺ 49,55
C-A-10T	Yeşil	220V	22 mm	10/200	₺ 49,55
C-A-11T	Sarı	220V	22 mm	10/200	₺ 49,55
C-A-21T	Mavi	220V	22 mm	10/200	₺ 49,55
C-A-31T	Beyaz	220V	22 mm	10/200	₺ 49,55
C-A-41T	Siyah	220V	22 mm	10/200	₺ 49,55



Logolu İşaretli Yaylı Butonlar

Referans No	Renk	Gerilim	Çap	Kutu / Koli	Birim Fiyatı (₺)
C-A-21DA	Mavi ↓	220V	22 mm	10/200	₺ 49,75
C-A-31A	Beyaz ↑	220V	22 mm	10/200	₺ 49,75
C-A-41A	Siyah ↓	220V	22 mm	10/200	₺ 49,75
C-A-10L	Lamba ⬆	220V	22 mm	10/200	₺ 49,75
C-A-10B	Zil ⬆	220V	22 mm	10/200	₺ 49,75



Kalcı Mandal Buton

Referans No	Gerilim	Çap	Kutu / Koli	Birim Fiyatı (₺)
C-A-10X (1/0)	220V	22 mm	10/200	₺ 53,55
C-A-20X (1/0/2)	220V	22 mm	10/200	₺ 67,95



KaYıcı Mandal Buton

Referans No	Gerilim	Çap	Kutu / Koli	Birim Fiyatı (₺)
C-A-10X/fu (1/0)	220V	22 mm	10/200	₺ 55,95
C-A-20XS/fu (1/0/2)	220V	22 mm	10/200	₺ 73,55



Kalcı Uzun Mandal Buton

Referans No	Gerilim	Çap	Kutu / Koli	Birim Fiyatı (₺)
C-A-10CX (1/0)	220V	22 mm	10/200	₺ 55,95
C-A-20CX (1/0/2)	220V	22 mm	10/200	₺ 73,55



Kalcı Mantar Buton

Referans No	Gerilim	Çap	Kutu / Koli	Birim Fiyatı (₺)
C-A-01ZS	220V	22 mm	10/200	₺ 57,95



Kalcı Anahtarlı Buton

Referans No	Gerilim	Çap	Kutu / Koli	Birim Fiyatı (₺)
C-A-10Y (1/0)	220V	22 mm	10/200	₺ 75,95
C-A-20YS (1/0/2)	220V	22 mm	10/200	₺ 93,55



KaYıcı Anahtarlı Buton

Referans No	Gerilim	Çap	Kutu / Koli	Birim Fiyatı (₺)
C-A-10Y/fu (1/0)	220V	22 mm	10/200	₺ 77,55
C-A-20YS/fu (1/0/2)	220V	22 mm	10/200	₺ 95,55



Metal İkiz Buton

Referans No	Gerilim	Çap	Kutu / Koli	Birim Fiyatı (₺)
C-A-RG		22 mm	10/200	₺ 85,95
C-A-DRG.220 (Işıklı)	220V	22 mm	10/200	₺ 117,35
C-A-DRG.24 (Işıklı)	24V	22 mm	10/200	₺ 117,35



İkiz Siyah Buton

Referans No	Gerilim	Çap	Kutu / Koli	Birim Fiyatı (₺)
C-A-11HRG		22 mm	10/200	₺ 85,95
C-A-11DHRG.220 (Işıklı)	220V	22 mm	10/200	₺ 117,35
C-A-11DHRG.24 (Işıklı)	24V	22 mm	10/200	₺ 117,35



İkiz Yuvarlak Buton

Referans No	Gerilim	Çap	Kutu / Koli	Birim Fiyatı (₺)
C-A-DRPG		22 mm	10/200	₺ 85,95
C-A-DRPG.220 (Işıklı)	220V	22 mm	10/200	₺ 117,35
C-A-DRPG.24 (Işıklı)	24V	22 mm	10/200	₺ 117,35



Anahtarlı Mantar Buton

Referans No	Renk	Gerilim	Çap	Kutu / Koli	Birim Fiyatı (₺)
C-A-01ZA	Kırmızı	220V	22 mm	10/200	₺ 85,45



KaYıcı Mantar Buton

Referans No	Renk	Gerilim	Çap	Kutu / Koli	Birim Fiyatı (₺)
C-A-01M	Kırmızı	220V	22 mm	10/200	₺ 53,95
C-A-10M	Yeşil	220V	22 mm	10/200	₺ 53,95



Işıklı Yaylı Buton 220 AC/DC

Referans No	Renk	Gerilim	Çap	Kutu / Koli	Birim Fiyatı (₺)
C-A-01D	Kırmızı	220V	22 mm	10/200	₺ 79,55
C-A-10D	Yeşil	220V	22 mm	10/200	₺ 79,55
C-A-11D	Sarı	220V	22 mm	10/200	₺ 79,55
C-A-21D	Mavi	220V	22 mm	10/200	₺ 79,55
C-A-31D	Beyaz	220V	22 mm	10/200	₺ 79,55



Işıklı Yaylı Buton 24 AC/DC

Referans No	Renk	Gerilim	Çap	Kutu / Koli	Birim Fiyatı (₺)
C-A-01D	Kırmızı	24V	22 mm	10/200	₺ 79,55
C-A-10D	Yeşil	24V	22 mm	10/200	₺ 79,55
C-A-11D	Sarı	24V	22 mm	10/200	₺ 79,55
C-A-21D	Mavi	24V	22 mm	10/200	₺ 79,55
C-A-31D	Beyaz	24V	22 mm	10/200	₺ 79,55



Işıklı Kalıcı Buton 220 AC/DC

Referans No	Renk	Gerilim	Çap	Kutu / Koli	Birim Fiyatı (₺)
C-A-01TD	Kırmızı	220V	22 mm	10/200	₺ 85,75
C-A-10TD	Yeşil	220V	22 mm	10/200	₺ 85,75
C-A-11TD	Sarı	220V	22 mm	10/200	₺ 85,75
C-A-21TD	Mavi	220V	22 mm	10/200	₺ 85,75
C-A-31TD	Beyaz	220V	22 mm	10/200	₺ 85,75



Işıklı Mandal Buton 220 AC/DC

Referans No	Renk	Gerilim	Çap	Kutu / Koli	Birim Fiyatı (₺)
C-A-01XD	Kırmızı	220V	22 mm	10/200	₺ 83,95
C-A-10XD	Yeşil	220V	22 mm	10/200	₺ 83,95
C-A-11XD	Sarı	220V	22 mm	10/200	₺ 83,95



Işıklı Mandal Buton 24 AC/DC

Referans No	Renk	Gerilim	Çap	Kutu / Koli	Birim Fiyatı (₺)
C-A-01XD	Kırmızı	24V	22 mm	10/200	₺ 83,95
C-A-10XD	Yeşil	24V	22 mm	10/200	₺ 83,95
C-A-11XD	Sarı	24V	22 mm	10/200	₺ 83,95



Işıklı Mandal Buton 220 AC/DC (1/0/2)

Referans No	Renk	Gerilim	Çap	Kutu / Koli	Birim Fiyatı (₺)
C-A-02XSD	Kırmızı	220V	22 mm	10/200	₺ 99,75
C-A-20XSD	Yeşil	220V	22 mm	10/200	₺ 99,75
C-A-21XSD	Sarı	220V	22 mm	10/200	₺ 99,75



Işıklı Mandal Buton 24 AC/DC (1/0/2)

Referans No	Renk	Gerilim	Çap	Kutu / Koli	Birim Fiyatı (₺)
C-A-02XSD	Kırmızı	220V	22 mm	10/200	₺ 99,75
C-A-20XSD	Yeşil	220V	22 mm	10/200	₺ 99,75
C-A-21XSD	Sarı	220V	22 mm	10/200	₺ 99,75



Buton Kontakları

Referans No	Renk	Kutu / Koli	Birim Fiyatı (₺)
C-101 (Açık)	Yeşil	100/1000	₺ 17,95
C-102 (Kapalı)	Kırmızı	100/1000	₺ 17,95



LAY5-EA42

LAY5-EA31



LAY5-EA51(B)

LAY5-EA51(L)



LAY5-EA3351

LAY5-EA3341



LAY5-ES142

LAY5-EA61(DA)



LAY5-ED21

LAY5-ES542

LAY5 PLASTİK BUTONLAR 22mm

Referans No	Açıklama	Renk	Kontak	Kutu / Koli	Birim Fiyatı (\$)
LAY5-EA21	Yaylı Buton	Siyah	NO	20/300	\$1,35
LAY5-EA31	Yaylı Buton	Yeşil	NO	20/300	\$1,35
LAY5-EA51	Yaylı Buton	Sarı	NO	20/300	\$1,35
LAY5-EA51(B)	Yaylı Zil Logolu	Sarı	NO	20/300	\$1,55
LAY5-EA51(L)	Yaylı Işık Logolu	Sarı	NO	20/300	\$1,55
LAY5-EA61	Yaylı Buton	Mavi	NO	20/300	\$1,35
LAY5-EA61(DA)	Yaylı Çift Oklu Buton	Mavi	NO	20/300	\$1,55
LAY5-EA42	Yaylı Buton	Kırmızı	NC	20/300	\$1,35
LAY5-EA3341	Yaylı Ok Logolu	Beyaz	NO	20/300	\$1,55
LAY5-EA3351	Yaylı Ok Logolu	Siyah	NO	20/300	\$1,55
LAY5-EC31	Mantar Yaylı	Yeşil	NC	20/200	\$2,75
LAY5-EC42	Mantar Yaylı	Kırmızı	NC	20/200	\$2,75
LAY5-ES142	Mantar Anahtarlı	Kırmızı	NC	20/200	\$5,50
LAY5-ES542	Mantar Kalıcı	Kırmızı	NO	20/200	\$1,95
LAY5-ED21	1/0 Mandal Kalıcı		NO	20/200	\$1,55
LAY5-EJ21	1/0 Mandal Kalıcı Uzun		NO	20/200	\$1,55
LAY5-ED33	1/0/2 Mandal Kalıcı		NO+NO	20/200	\$2,75
LAY5-EJ33	1/0/2 Mandal Kalıcı Uzun		NO+NO	20/200	\$2,75
LAY5-ED41	1/0 Mandal Yaylı		NO	20/200	\$1,55
LAY5-EJ41	1/0 Mandal Yaylı Uzun		NO	20/200	\$1,55
LAY5-ED53	1/0/2 Mandal Yaylı		NO+NO	20/200	\$2,75
LAY5-EJ53	1/0/2 Mandal Yaylı Uzun		NO+NO	20/200	\$2,75
LAY5-EG21	0/1 Anahtarlı Buton		NO	20/200	\$3,90
LAY5-EG33	1/0/2 Anahtarlı Buton		NO+NO	20/200	\$4,50
LAY5-EG61	0/1 Anahtarlı Buton		NO	20/200	\$3,90
LAY5-EL8325	İkiz Buton Start / Stop		NO+NC	20/200	\$3,55
LAY5-EL8325(DA)	İkiz Buton Çift Ok		NO+NO	20/200	\$3,75

GLORIOUS®

LAY5 METAL BUTONLAR 22mm

Referans No	Açıklama	Renk	Kontak	Kutu / Koli	Birim Fiyatı (\$)
LAY5-BA21	Yaylı Buton	Siyah	NO	20/300	\$2,10
LAY5-BA31	Yaylı Buton	Yeşil	NO	20/300	\$2,10
LAY5-BA51	Yaylı Buton	Sarı	NO	20/300	\$2,10
LAY5-BA51(B)	Yaylı Zil Logolu	Sarı	NO	20/300	\$2,25
LAY5-BA51(L)	Yaylı Işık Logolu	Sarı	NO	20/300	\$2,25
LAY5-BA61	Yaylı Buton	Mavi	NO	20/300	\$2,10
LAY5-BA61(DA)	Yaylı Çift Oklu Buton	Mavi	NO	20/300	\$2,25
LAY5-BA42	Yaylı Buton	Kırmızı	NC	20/300	\$2,10
LAY5-BA3341	Yaylı Ok Logolu	Beyaz	NO	20/300	\$2,25
LAY5-BA3351	Yaylı Ok Logolu	Siyah	NO	20/300	\$2,25
LAY5-BC31	Mantar Yaylı	Yeşil	NO	20/200	\$2,80
LAY5-BC42	Mantar Yaylı	Kırmızı	NC	20/200	\$2,80
LAY5-BS142	Mantar Anahtarlı	Kırmızı	NC	20/200	\$4,95
LAY5-BS542	Mantar Kalıcı	Kırmızı	NC	20/200	\$2,80
LAY5-BD21	1/0 Mandal Kalıcı		NO	20/200	\$2,45
LAY5-BJ21	1/0 Mandal Kalıcı Uzun		NO	20/200	\$2,45
LAY5-BD33	1/0/2 Mandal Kalıcı		NO+NO	20/200	\$3,10
LAY5-BJ33	1/0/2 Mandal Kalıcı Uzun		NO+NO	20/200	\$3,10
LAY5-BD41	1/0 Mandal Yaylı		NO	20/200	\$2,45
LAY5-BJ41	1/0 Mandal Yaylı Uzun		NO	20/200	\$2,45
LAY5-BD53	1/0/2 Mandal Yaylı		NO+NO	20/200	\$3,10
LAY5-BJ53	1/0/2 Mandal Yaylı Uzun		NO+NO	20/200	\$3,10
LAY5-BG21	0/1 Anahtarlı Buton		NO	20/200	\$4,65
LAY5-BG33	1/0/2 Anahtarlı Buton		NO+NO	20/200	\$5,22
LAY5-BG61	Kilitli Buton Yaylı 1/0		NO	20/200	\$4,65
LAY5-BG73	Kilitli Buton Yaylı 1/0/2		NO+NO	20/200	\$5,22
LAY5-BW3361	Yaylı Işıklı Buton 220V / 24V		NO	20/200	\$5,80
LAY5-BW3462	Yaylı Işıklı Buton 220V / 24V		NC	20/200	\$5,80
LAY5-BW3561	Yaylı Işıklı Buton 220V / 24V		NO	20/200	\$5,80
LAY5-BK2365	Işıklı Mandal Buton 220V / 24V		NO	20/200	\$5,50
LAY5-BK2465	Işıklı Mandal Buton 220V / 24V		NC	20/200	\$5,50
LAY5-BK2565	Işıklı Mandal Buton 220V / 24V		NO	20/200	\$5,50

GLORIOUS®



LAY5-BL 8325

LAY5 İKİZ BUTONLAR

Referans No	Açıklama	Kontak	Kutu / Koli	Birim Fiyatı (\$)
LAY5-BL 8325	İkiz Buton	NO+NC	20/200	\$4,45
LAY5-BL 8425	İkiz Buton Çıkıntılı Stop	NO+NC	20/200	\$4,45



LAY5-BE101



LAY5-BE102

LAY5 SERİSİ BUTON KONTAKLARI

Referans No	Açıklama	Renk	Kontak	Kutu / Koli	Birim Fiyatı (\$)
LAY5-BE101	İlave Kontak	Yeşil	NO	100/1500	\$0,69
LAY5-BE102	İlave Kontak	Kırmızı	NC	100/1500	\$0,69



TB4-BE101



TB4-BE102

TB4 - TB5 SERİSİ BUTON KONTAKLARI

Referans No	Açıklama	Renk	Kontak	Kutu / Koli	Birim Fiyatı (\$)
TB4-BE101	İlave Kontak	Yeşil	NO	200/2000	\$1,25
TB4-BE102	İlave Kontak	Kırmızı	NC	200/2000	\$1,25

POTANSİYOMETRE

Referans No	Açıklama	Kutu / Koli	Birim Fiyatı (\$)
LAY5-DWQ22 5K	Potansiyometre 5 KOHM	10/500	\$9,75
LAY5-DWQ22 10K	Potansiyometre 10 KOHM	10/500	\$9,75



IŞIKLI ANAHTAR

Referans No	Açıklama	Kutu / Koli	Birim Fiyatı (\$)
ZT-23 R220	DAR IŞIKLI TEKLİ ANAHTAR	100/1000	\$0,96
ZT-KCD-4201N R220	GENİŞ IŞIKLI TEKLİ ANAHTAR	100/1000	\$1,49

BUTON ETİKETİ

Referans No	Açıklama	Kontak	Kutu / Koli	Birim Fiyatı (\$)
LAY5-ER90	Emergency	Q=99 mm	1/100	\$0,55
LAY5-ER60	Etiket	Q=99 mm	1/100	\$0,85



BUTON İÇİN LED AMPUL

Referans No	Açıklama	Gerilim	Kutu / Koli	Birim Fiyatı (\$)
LAY-BW/R	Kırmızı Led	220V & 24V	1/50	\$0,90
LAY-BW/G	Yeşil Led	220V & 24V	1/50	\$0,90
LAY-BW/Y	Sarı Led	220V & 24V	1/50	\$0,90



BUTON KILIFLARI

Referans No	Açıklama	Renk	Kutu / Koli	Birim Fiyatı (\$)
LAY5-22A	Buton Kılıfları	Şeffaf	500/5000	\$0,55



BUTON MUHAFAZA

Referans No	Açıklama	Kontak	Kutu / Koli	Birim Fiyatı (\$)
F03	Çap 22 mm Emergency	Q=60 mm	40/600	\$0,95



TB5 PLASTİK BUTONLAR 22mm

Referans No	Açıklama	Renk	Kontak	Kutu / Koli	Birim Fiyatı (\$)
TB5-AA21	Yaylı Buton	Siyah	NO	20/300	\$2,47
TB5-AA31	Yaylı Buton	Yeşil	NO	20/300	\$2,47
TB5-AA51	Yaylı Buton	Sarı	NO	20/300	\$2,47
TB5-AA51(B)	Yaylı Zil Logolu	Sarı	NO	20/300	\$2,77
TB5-AA51(L)	Yaylı Işık Logolu	Sarı	NO	20/300	\$2,77
TB5-AA61	Yaylı Buton	Mavi	NO	20/300	\$2,47
TB5-AA61(DA)	Yaylı Çift Oklu Buton	Mavi	NO	20/300	\$2,77
TB5-AA42	Yaylı Buton	Kırmızı	NC	20/300	\$2,47
TB5-AA3341	Yaylı Ok Logolu	Beyaz	NO	20/300	\$2,77
TB5-AA3351	Yaylı Ok Logolu	Siyah	NO	20/300	\$2,77
TB5-AC31	Mantar Yaylı	Yeşil	NO	20/200	\$4,37
TB5-AC42	Mantar Yaylı	Kırmızı	NC	20/200	\$4,35
TB5-AS542	Mantar Kalıcı	Kırmızı	NC	20/200	\$4,35
TB5-AD21	1/0 Mandal Kalıcı		NO	20/200	\$3,25
TB5-AJ21	1/0 Mandal Kalıcı Uzun		NO	20/200	\$3,25
TB5-AD33	1/0/2 Mandal Kalıcı		NO+NO	20/200	\$4,35
TB5-AJ33	1/0/2 Mandal Kalıcı Uzun		NO+NO	20/200	\$4,35
TB5-AD41	1/0 Mandal Yaylı		NO	20/200	\$3,25
TB5-AJ41	1/0 Mandal Yaylı Uzun		NO	20/200	\$3,25
TB5-AD53	1/0/2 Mandal Yaylı		NO+NO	20/200	\$4,35
TB5-AJ53	1/0/2 Mandal Yaylı Uzun		NO+NO	20/200	\$4,35
TB5-AG21	0/1 Anahtarlı Buton		NO	20/200	\$6,25
TB5-AG33	1/0/2 Anahtarlı Buton		NO+NO	20/200	\$7,25
TB5-AL8325	İkiz Buton Start / Stop		NO+NC	20/200	\$6,35
TB5-AL8325(DA)	İkiz Buton Çift Ok		NO+NO	20/200	\$6,35
TB5-AW3361	Yaylı Işıklı Buton 220V / 24V		NO	20/200	\$5,96
TB5-AW3462	Yaylı Işıklı Buton 220V / 24V		NC	20/200	\$5,96
TB5-AW3561	Yaylı Işıklı Buton 220V / 24V		NO	20/200	\$5,96
TB5-AK2365	Işıklı Mandal Buton 220V / 24V		NO	20/200	\$8,33
TB5-AK2465	Işıklı Mandal Buton 220V / 24V		NC	20/200	\$8,33
TB5-AK2565	Işıklı Mandal Buton 220V / 24V		NO	20/200	\$8,33



GLORIOUS®





COB-C SERİSİ VİNÇ BUTONLARI

Referans No	Açıklama	Kutu / Koli	Birim Fiyatı (\$)
COB-C1	Hızlı İki Hareketli Buton	1/50	\$19,55
COB-C2	Hızlı Dört Hareketli Buton	1/40	\$27,95
COB-C3	Hızlı Altı Hareketli Buton	1/30	\$35,95



XAC SERİSİ ÇİFT HIZLI VİNÇ BUTONLARI

Referans No	Açıklama	Kutu / Koli	Birim Fiyatı (\$)
XAC-A4913	Çift Hızlı Dört Hareketli Buton	1/20	\$51,15
XAC-A6913	Çift Hızlı Altı Hareketli Buton	1/20	\$62,17



COB SERİSİ VİNÇ BUTONLARI

Referans No	Açıklama	Kutu / Koli	Birim Fiyatı (\$)
COB-61	İki Hareketli Vinç Butonu	1/72	\$5,55
COB-62	Dört Hareketli Vinç Butonu	1/48	\$6,95
COB-63	Altı Hareketli Vinç Butonu	1/42	\$9,75
COB-64	Sekiz Hareketli Vinç Butonu	1/30	\$10,55



LAY5-EPC

LİFT BUTONLARI

Referans No	Açıklama	Kutu / Koli	Birim Fiyatı (\$)
LAY5-T1	İkili Buton Grubu	1/50	\$14,55
LAY5-T2	Üçlü Buton Grubu	1/50	\$20,95
LAY5-T3	Dörtlü Buton Grubu	1/50	\$25,75
LAY5-T2M	İki Hareketli Acil Stoplu Buton Grubu	1/50	\$19,69
LAY5-T4M	Dört Hareketli Acil Stoplu Buton Grubu	1/50	\$25,20
LAY5-EPC	T Serisi Buton Muhafazası	1/50	\$5,08
LAY5-COB21E	Monofaze Vinç Butonu	1/50	\$16,55



LAY5-COB21E



LAY5-T1

LAY5-T2

LAY5-T3

LAY5-T2M

LAY5-T4M

ASANSÖR REVİZYON BUTON KUTULARI



Referans No	Açıklama	Kutu / Koli	Birim Fiyatı (\$)
XAL-J174	Kutulu Acil Stop	1/100	\$4,50
XAL-J174 (M)	Kutulu Acil Stop Muhafazalı	1/100	\$4,95
LAY5-DJBOS444P	4'lü Revizyon Kutusu Plastik Buton	1/30	\$12,10
LAY5-DJBOS445P	4'lü Revizyon Kutusu Metal Buton	1/30	\$16,85
LAY5-DJBOS544P	5'li Revizyon Kutusu Plastik Buton	1/30	\$13,30
LAY5-DJBOS545P	5'li Revizyon Kutusu Metal Buton	1/30	\$19,40
LAY5-DJBOS645P	6'li Revizyon Kutusu Plastik Buton	1/30	\$15,00
LAY5-DJBOS446P	9'li Revizyon Kutusu Plastik Buton	1/20	\$21,20
LAY5-DJBOS1(12)	Kutulu Pili Buzzer	1/100	\$8,00
XAL-J175 (M)	Kutulu Acil Stop Muhafazalı (Eco Seri)	1/100	\$3,50
LAY5-CNT7M	7'li Revizyon Kutusu Plastik Buton	1/40	\$21,10
LAY5-HEA51B	Kutulu Alarm Butonu	1/100	\$3,46
LAY5-HEA51L	Kutulu Aydınlatma Butonu	1/100	\$3,46
LAY5-HBG21	Kutulu Revizyon Reset Anahtar	1/100	\$4,85
LAY5-HB	Kutulu Işıklı Buzzer	1/100	\$4,05



BUTON KUTULARI



Referans No	Açıklama	Renk	Kutu / Koli	Birim Fiyatı (\$)
HJ9-1	1'li Buton Kutusu	Beyaz/Sarı	1/100	\$1,97
HJ9-2	2'li Buton Kutusu	Beyaz/Sarı	1/100	\$2,55
HJ9-3	3'lü Buton Kutusu	Beyaz/Sarı	1/75	\$3,15
HJ9-4	4'lü Buton Kutusu	Beyaz/Sarı	1/50	\$3,95
HJ9-5	5'li Buton Kutusu	Beyaz/Sarı	1/50	\$5,75
HJ9-6	6'li Buton Kutusu	Beyaz/Sarı	1/50	\$6,55

KUTULU TRİFAZE ŞALTERLER



Referans No : CBSN-310
 Açıklama : 3x10A Metal Gövde
 Kutu / Koli : 10/180
 Fiyat : \$7,55



Referans No : CBSN-330
 Açıklama : 3x30A Metal Gövde
 Kutu / Koli : 10/120
 Fiyat : \$11,75



Referans No : CFS-502

Açıklama : Pedal

Kutu / Koli : 1/20

Fiyat : \$36,55

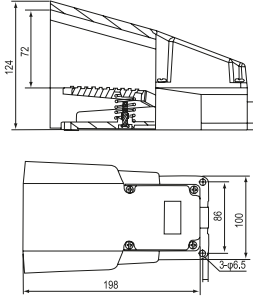

Referans No : MD-16H

Açıklama : Pedal

Kutu / Koli : 1/20

Fiyat : \$75,35



Referans No : CFS-402

Açıklama : Pedal

Kutu / Koli : 1/20

Fiyat : \$25,75

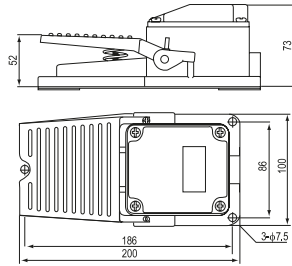

Referans No : CFS-302

Açıklama : Pedal

Kutu / Koli : 1/20

Fiyat : \$33,55

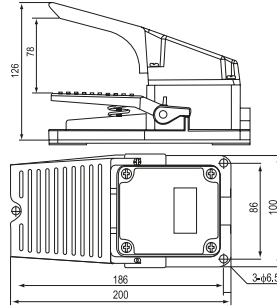

Referans No : CFS-01

Açıklama : Pedal

Kutu / Koli : 1/60

Fiyat : Kablolu
\$7,95



Referans No : CFS-1

Açıklama : Pedal

Kutu / Koli : 1/60

Fiyat : Kablolu
\$8,75



Referans No : CFS-2

Açıklama : Pedal

Kutu / Koli : 1/60

Fiyat : Kablolu
\$11,98



Referans No : CFS-3

Açıklama : Pedal

Kutu / Koli : 1/60

Fiyat : Kablolu
\$14,95



120x120x25 AXIAL FAN

Model	Gerilim	Akım(A)	Güç(WATT)	Devir(RPM)	DBAm3/h	Kutu / Koli	Birim Fiyatı (\$)
120x120x25	220AC	0,14/0,12	22/21	2600/3000	90/100	1/40	\$7,95
120x120x25	24DC	0,14/0,13	22/21	2600/3000	90/100	1/40	\$7,95
120x120x25	12DC	0,14/0,14	22/21	2600/3000	90/100	1/40	\$7,95



120x120x38 AXIAL FAN

Model	Gerilim	Akım(A)	Güç(WATT)	Devir(RPM)	DBAm3/h	Kutu / Koli	Birim Fiyatı (\$)
120x120x38	220AC	0,14/0,12	22/21	2600/3000	90/100	1/40	\$7,95
120x120x38 RULMANLI	220AC	0,14/0,12	22/21	2600/3000	90/100	1/40	\$15,75
120x120x38	24DC	0,14/0,13	22/21	2600/3000	90/100	1/40	\$7,95
120x120x38	12DC	0,14/0,14	22/21	2600/3000	90/100	1/40	\$7,95



172x150x50 AXIAL FAN

Model	Gerilim	Akım(A)	Güç(WATT)	Devir(RPM)	DBAm3/h	Kutu / Koli	Birim Fiyatı (\$)
172x150x50	220AC	0,23/0,21	36/35	2300/2500	150/180	1/12	\$25,75
172x150x50 RULMANLI	220AC	0,23/0,21	36/35	2300/2500	150/180	1/12	\$33,75
172x150x50	24DC	0,23/0,21	36/35	2300/2500	150/180	1/12	\$25,75
172x150x50	12DC	0,23/0,21	36/35	2300/2500	150/180	1/12	\$25,75



225x225x80 AXIAL FAN

Model	Gerilim(VAC)	Akım(A)	Güç(WATT)	Devir(RPM)	DBAm3/h	Kutu / Koli	Birim Fiyatı (\$)
225x225x80	115	0,74/0,70	80/75	2500/2850	618/760	1/12	\$105,75
225x225x80	220-240	0,40/0,35	80/75	2500/2850	618/760	1/12	\$105,75
225x225x80	380-420	0,32/0,28	80/75	2500/2850	618/760	1/12	\$105,75



280x280x80 AXIAL FAN

Model	Gerilim(VAC)	Akım(A)	Güç(WATT)	Devir(RPM)	DBAm3/h	Kutu / Koli	Birim Fiyatı (\$)
280x280x80	115	1.2/1.0	120/110	2400/2500	1300/1500	1/12	\$138,35
280x280x80	220-240	0.55/0.50	120/110	2400/2500	1300/1500	1/12	\$138,35
280x280x80	380-420	0.36/0.32	120/110	2400/2500	1300/1500	1/12	\$138,35

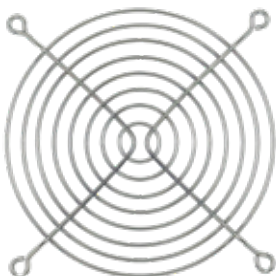

Referans No : 120x120x38

Açıklama : Fan Koruma Teli

Kutu / Koli : 100/1000

Fiyat : \$1,75

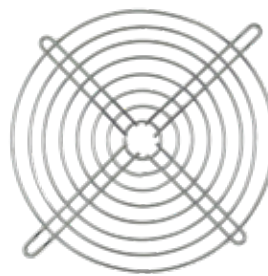

Referans No : 172x150x50

Açıklama : Fan Koruma Teli

Kutu / Koli : 100/1000

Fiyat : \$2,85



CLS-101 (TGB-101)

Doğrusal Kısa Pim

Kutu/Koli :10/100

Fiyat :\$6,75

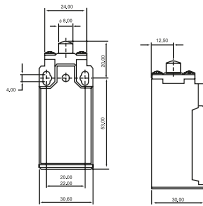

CLS-103 (TGB-102)

Doğrusal Pim Makara

Kutu/Koli :10/100

Fiyat :\$6,75

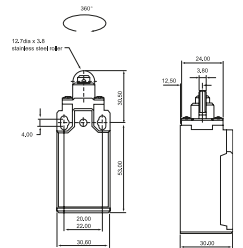

CLS-103R (TGB-102R)

Doğrusal Pim Makara Res.

Kutu/Koli :10/100

Fiyat :\$7,15

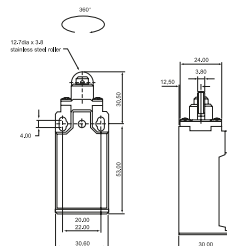

CLS-111 (TGB-103)

Doğrusal Pim Makara

Kutu/Koli :10/100

Fiyat :\$6,75

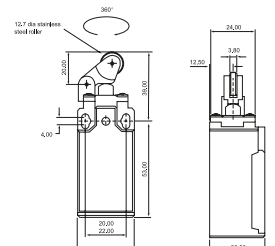



CLS-121 (TGB-104)
Açısal Kol Makara
Kutu/Koli :10/100
Fiyat :\$6,75

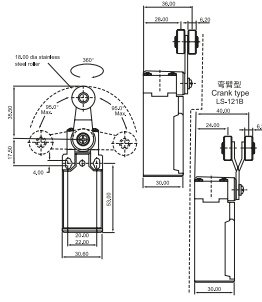

CLS-127 (TGB-105)
Doğrusal Pim Makara
Kutu/Koli :10/100
Fiyat :\$6,75

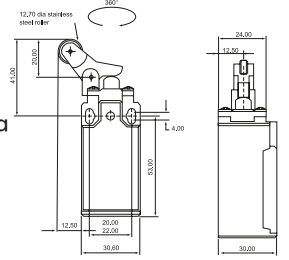

CLS-131 (TGB-108)
Açısal Ayarlı Kol Makara
Kutu/Koli :10/100
Fiyat :\$6,95

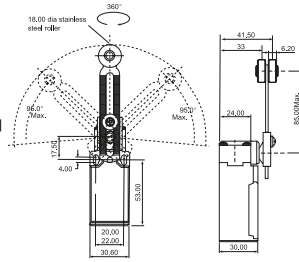

CLS-161 (TGB-106)
Çok Yönlü Tel
Kutu/Koli :10/100
Fiyat :\$6,95

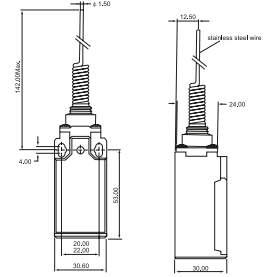

CLS-171 (TGB-107)
Çok Yönlü Spiral
Kutu/Koli :10/100
Fiyat :\$6,95

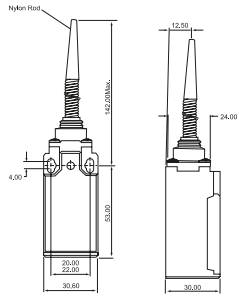

CLS-181 (TGB-109)
Çok Yönlü Spiral
Kutu/Koli :10/100
Fiyat :\$6,95

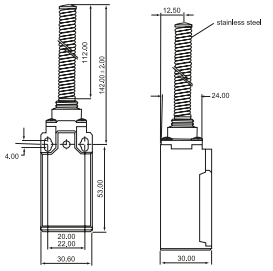

CLS-191 (TGB-110)
Açısal Ayarlı Kol Makara
Kutu/Koli :10/100
Fiyat :\$6,95

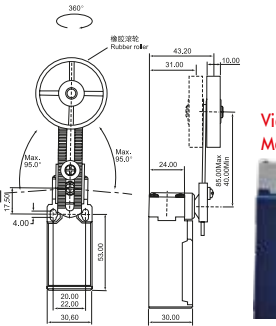

CLS-191A (TGB-110A)
Açısal Ayarlı Kol
ve Vidalı Makara
Kutu/Koli :10/100
Fiyat :\$8,75

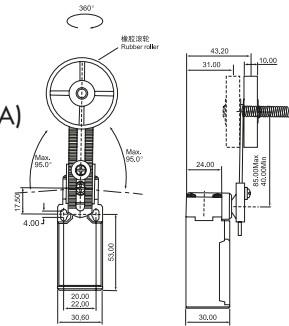

CLS-191R (TGB-110R)
Açısal Ayarlı Kol Makara
Resetli
Kutu/Koli :10/100
Fiyat :\$8,75

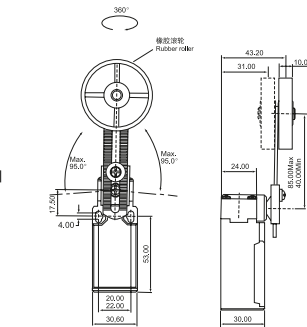

CLS-KONTAK (TGB)
Siviç İç Kontak
Kutu/Koli :10/100
Fiyat :\$3,15



CSA-001(TGB M001)

Doğrusal Kısa Pim

Kutu/Koli :10/100

Fiyat :\$17,95

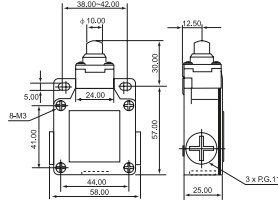

CSA-003(TGB M003)

Doğrusal Pim Makara

Kutu/Koli :10/100

Fiyat :\$17,95

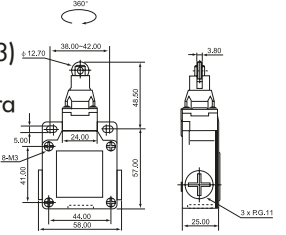

CSA-012(TGB M012)

Yatay Makaralı Sivic

Kutu/Koli :10/100

Fiyat :\$17,95

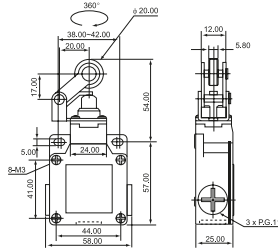

CSA-021(TGB M021)

Açısal Kol Makara

Kutu/Koli :10/60

Fiyat :\$17,95

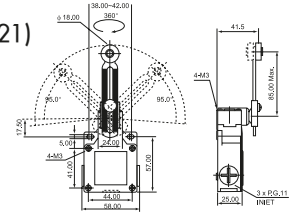

CSA-031(TGB M031)

Açısal Ayarlı Kol Makara

Kutu/Koli :10/60

Fiyat :\$17,95

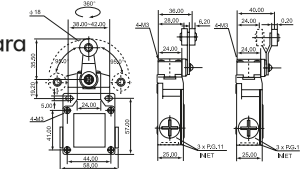

CSA-061(TGB M061)

Çok Yönlü Tel

Kutu/Koli :10/70

Fiyat :\$17,95

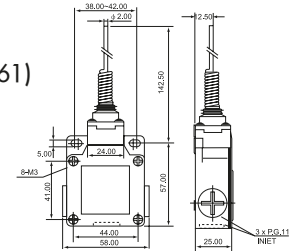

CSA-071(TGB M071)

Çok Yönlü Spiral

Kutu/Koli :10/70

Fiyat :\$17,95

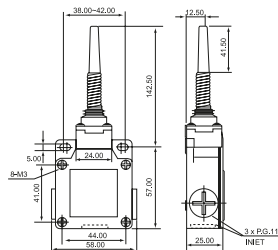

CSA-081(TGB M081)

Çok Yönlü Spiral

Kutu/Koli :10/70

Fiyat :\$17,95

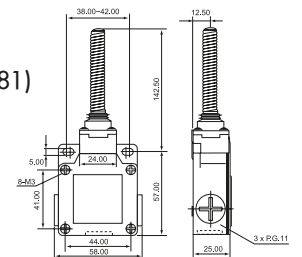



CWLCA2-2
TGB-5-104
 Yatay Kol Makaralı
 Kutu/Koli : 10/90
 Fiyat : \$29,79

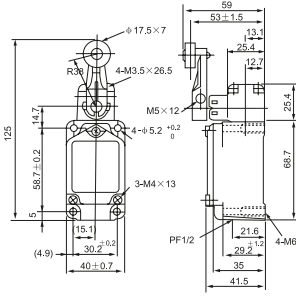

CWLCA12-2-Q
TGB-5-108
 Açısal Ayarlı Kol
 Kutu/Koli : 10/90
 Fiyat : \$29,79

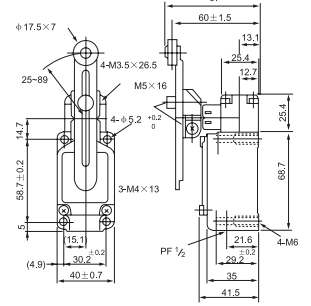

CWLCL
TGB-5-107
 Ayarlı Çubuk
 Kutu/Koli : 10/90
 Fiyat : \$29,79

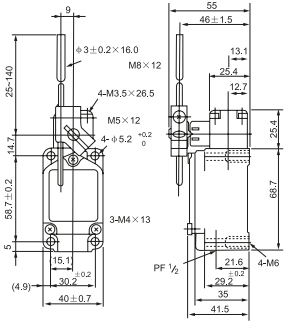

CWLCA32-41
TGB-5-105
 Yön Sivici Kalıcı
 Kutu/Koli : 10/80
 Fiyat : \$29,79

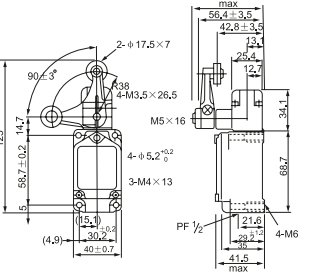

CWLD1
TGB-5-110
 Makaralı Sivici
 Kutu/Koli : 10/80
 Fiyat : \$29,79

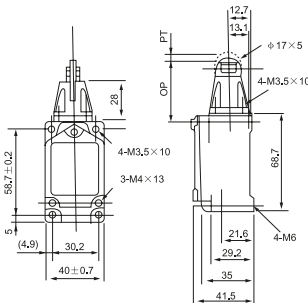

CWLD3
TGB-5-111
 Pimli Sivici
 Kutu/Koli : 10/80
 Fiyat : \$29,79

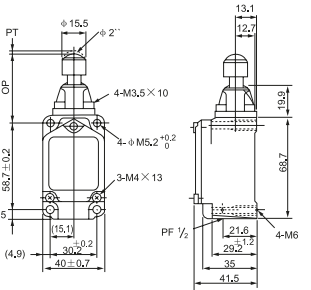

CWLNJ
TGB-5-106
 Çok Yönlü Spiral
 Kutu/Koli : 10/80
 Fiyat : \$29,79

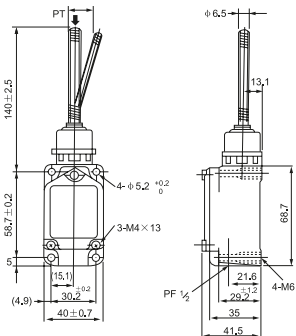

CWLNJ-2
TGB-5-112
 Çok Yönlü Spiral
 Kutu/Koli : 10/80
 Fiyat : \$29,79

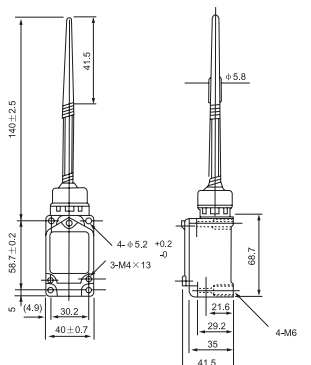



(TGB-8-104)TZ-8104M
Açısal Kol Makara
Kutu/Koli :10/100
Fiyat :\$13,95

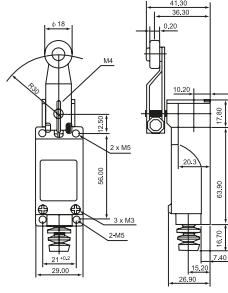

(TGB-8-107)TZ-8107
Ayarlı Çubuk Kol
Kutu/Koli :10/100
Fiyat :\$13,95

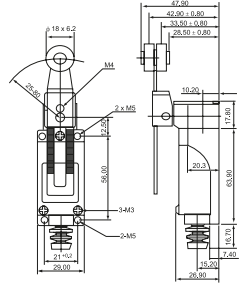

(TGB-8-108)TZ-8108M
Açısal Ayarlı Makara Kol
Kutu/Koli :10/100
Fiyat :\$13,95

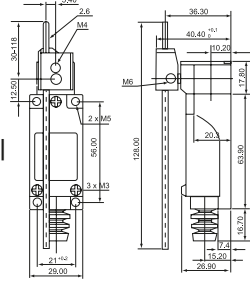

(TGB-8-111)TZ-8111
Doğrusal Kısa Pim
Kutu/Koli :10/100
Fiyat :\$13,95

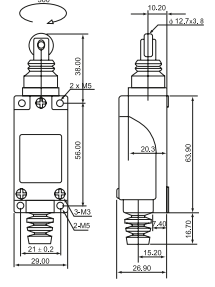

(TGB-8-112)TZ-8112
Doğrusal Pim Makara
Kutu/Koli :10/100
Fiyat :\$13,95

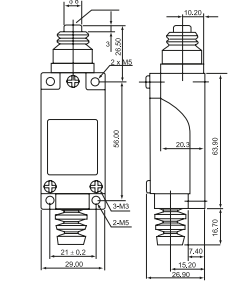

(TGB-8-122)TZ-8122
Doğrusal Pim Makara
Kutu/Koli :10/100
Fiyat :\$13,95

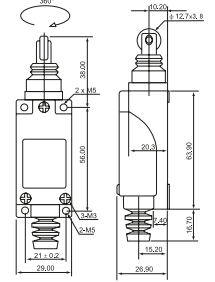

(TGB-8-166)TZ-8166
Çok Yönlü Spiral
Kutu/Koli :10/100
Fiyat :\$13,95

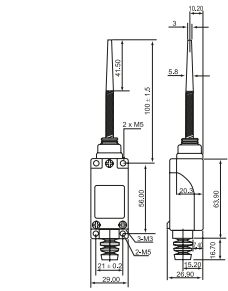

(TGB-8-167)TZ-8167
Çok Yönlü Spiral
Kutu/Koli :10/100
Fiyat :\$13,95

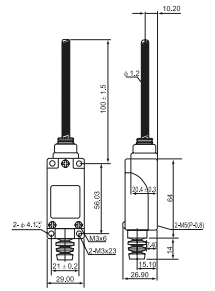

(TGB-8-168)TZ-8168
Çok Yönlü Spiral
Kutu/Koli :10/100
Fiyat :\$13,95

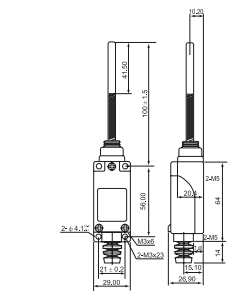

(TGB-8-169)TZ-8169
Çok Yönlü Tel
Kutu/Koli :10/100
Fiyat :\$13,95

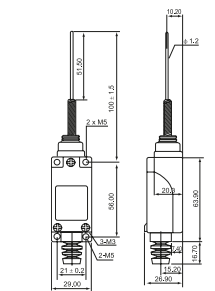



CMV-100D(TGB-V15)

Mini Pimli Siviç

Kutu/Koli :100/1000

Fiyat :\$1,09

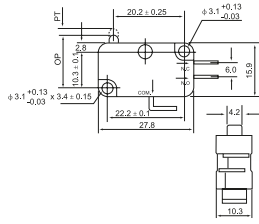

CMV-101D(TGB-V152)

Mini Palet Siviç

Kutu/Koli :100/1000

Fiyat :\$1,11

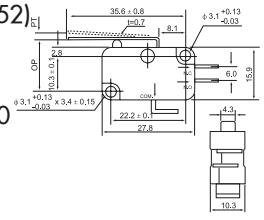

CMV-102D(TGB-V151)

Mini Kısa Palet Siviç

Kutu/Koli :100/1000

Fiyat :\$1,11

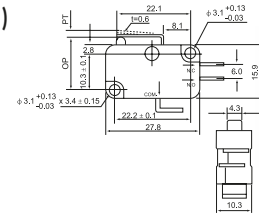

CMV-103D(TGB-V156)

Mini Uzun Makaralı Siviç

Kutu/Koli :100/1000

Fiyat :\$1,26

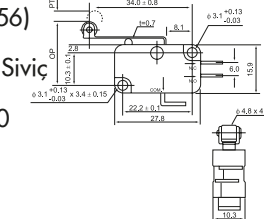

CMV-104D(TGB-V155)

Mini Kısa Makaralı Siviç

Kutu/Koli :100/1000

Fiyat :\$1,26

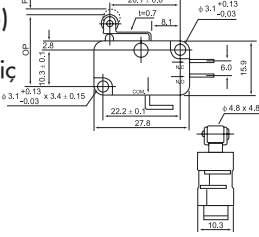

CMV-105D(TGB-V153)

Mini Uzun Palet Siviç

Kutu/Koli :100/1000

Fiyat :\$1,26

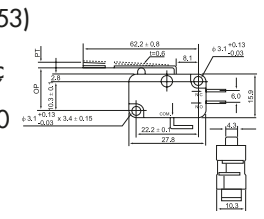

CMV-106D(TGB-V154)

Mini Çengel Siviç

Kutu/Koli :100/1000

Fiyat :\$1,26

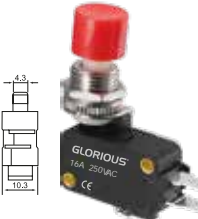
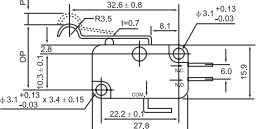

DS-438

Dikey Tahrikli Kırmızı Kafalı

Kutu/Koli :50/500

Fiyat :\$4,55

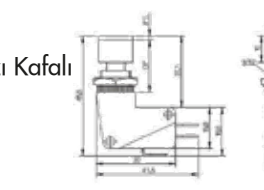

CZ SERİSİ SIVIÇLER



CZ-7310(TGB-7-7310)

Doğrusal Metal Pim

Kutu/Koli :10/240

Fiyat :\$9,35

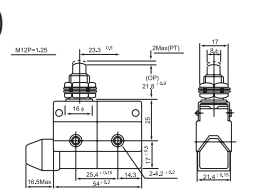

CZ-7311(TGB-7-7311)

Doğrusal Metal Makara

Kutu/Koli :10/240

Fiyat :\$9,35

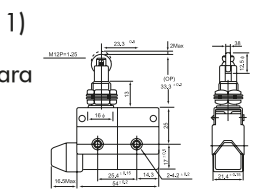

CZ-7312(TGB-7-7312)

Doğrusal Metal Makara

Kutu/Koli :10/240

Fiyat :\$9,35

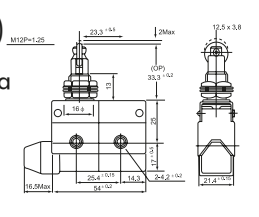

TGB-B

Kapı Siviç

Kutu/Koli :100/1000

Fiyat :\$3,37



CM - 1300 (TGB-G-B)

Küçük Pimli Siviç

Kutu/Koli :20/400

Fiyat :\$3,57

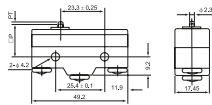

CM - 1301 (TGB-GL-B)

Palet Siviç

Kutu/Koli :20/400

Fiyat :\$3,95

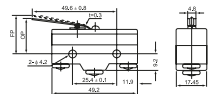

CM - 1303 (TGB-GL2-B)

Makaralı Siviç

Kutu/Koli :20/400

Fiyat :\$4,25

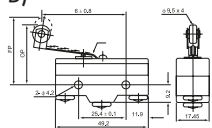

CM - 1305 (TGB-S-B)

Uzun Pimli Siviç

Kutu/Koli :20/400

Fiyat :\$4,55

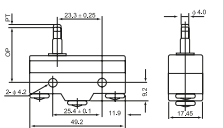

SU SEVİYE ŞAMANDIRA ANAHTARLARI (80mm x 159mm)



Referans No : 3SY-2-1,6M
Açıklama : 1,6M Kablolu
Kontakt : NO+NC
Kutu / Koli : 1/30
Fiyat : \$10,65



Referans No : 3SY-2-3M
Açıklama : 3M Kablolu
Kontakt : NO+NC
Kutu / Koli : 1/30
Fiyat : \$12,47



Referans No : 3SY-2-5M
Açıklama : 5M Kablolu
Kontakt : NO+NC
Kutu / Koli : 1/30
Fiyat : \$15,25

SU SEVİYE ŞAMANDIRA ANAHTARLARI (80mm x 159mm) (KAUÇUK KABLO)



Referans No : 3SY-2-1,6M
Açıklama : 1,6M Kablolu
Kontakt : NO+NC
Kutu / Koli : 1/30
Fiyat : \$12,05



Referans No : 3SY-2-3M
Açıklama : 3M Kablolu
Kontakt : NO+NC
Kutu / Koli : 1/30
Fiyat : \$14,37



Referans No : 3SY-2-5M
Açıklama : 5M Kablolu
Kontakt : NO+NC
Kutu / Koli : 1/30
Fiyat : \$17,57

TOGGLE SİVİÇ ANAHTARLARI



Referans No : C511B(XT-11B)
Açıklama : ON-OFF 15A
Kontakt : NO (2Pin)
Kutu / Koli : 20/480
Fiyat : \$3,25



Referans No : C512B
Açıklama : ON-ON 15A
Kontakt : NO-NO (3Pin)
Kutu / Koli : 20/480
Fiyat : \$3,55



Referans No : C513B
Açıklama : ON-OFF-ON 15A
Kontakt : NO-NO (3Pin)
Kutu / Koli : 20/480
Fiyat : \$3,55



Referans No : C521B
Açıklama : ON-OFF 15A
Kontakt : 2NO (4Pin)
Kutu / Koli : 20/480
Fiyat : \$4,15



Referans No : C522B
Açıklama : ON-ON 15A
Kontakt : 2NO-2NC (6Pin)
Kutu / Koli : 20/480
Fiyat : \$4,65



Referans No : C523B
Açıklama : ON-OFF-ON 15A
Kontakt : 2NO-2NC (6Pin)
Kutu / Koli : 20/480
Fiyat : \$4,65





RAY KLEMENS VİDALI

Referans No	Açıklama	Renk	Kutu / Koli	Birim Fiyatı (\$)
FJ3N	2,5 mm ²	●●●●●●	60/2040	\$0,49
FJ5N	4 mm ²	●●●●●●	50/1700	\$0,57
FJ6N	6 mm ²	●●●●●●	40/1200	\$0,89
FJ10N	10 mm ²	●	30/1020	\$1,29
FJ16N	16 mm ²	●	50/850	\$1,66
FJ25NL	25 mm ²	●	32/544	\$2,48
FJ35NH	35 mm ²	●	28/476	\$3,15

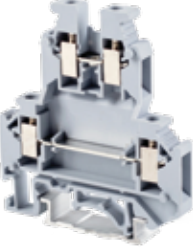

RAY KLEMENS ÇİFT KATLI VİDALI

Referans No	Açıklama	Renk	Kutu / Koli	Birim Fiyatı (\$)
FJJK3	2,5 mm ²	●●●●●●	100/1200	\$1,45
FJJK5	4 mm ²	●●●●●●	80/960	\$1,75



TOPRAKLAMA KLEMENSİ VİDALI

Referans No	Açıklama	Renk	Kutu / Koli	Birim Fiyatı (\$)
FJ3N/D	2,5 mm ²	●	60/1800	\$2,14
FJ5N/D	4 mm ²	●	50/1700	\$2,41
FJ6N/D	6 mm ²	●	40/1200	\$2,78
FJ10N/D	10 mm ²	●	30/1020	\$2,99



KLEMENS KAPAĞI

Referans No	Açıklama	Kutu / Koli	Birim Fiyatı (\$)
D-FJ4/10	VİDALI 4-10 MM ² İÇİN	100	\$0,27
D-FJ16	VİDALI 16 MM ² İÇİN	100	\$0,32
D-FJJK3/5	İKİ KATLI VİDALI İÇİN	100	\$0,41

ÜST SABİT KÖPRÜ

Referans No	Açıklama	Kutu / Koli	Birim Fiyatı (\$)
FBRN10-4N	(FJ1.5N)Vidalı 1,5 mm ² için	20	\$1,41
FBI10-6	(FJ2.5B)Vidalı 2,5 mm ² için	20	\$1,46
FBR110-5N	(FJ3N)Vidalı 2,5 mm ² için	20	\$1,41
FBI10-6	(FJ5N)Vidalı 4 mm ² için	20	\$1,46
FBI10-8	(FJ6N)Vidalı 6 mm ² için	20	\$2,13
FBI10-10	(FJ10N)Vidalı 10 mm ² için	20	\$2,78
FBI10-12	(FJ16N)Vidalı 16 mm ² için	10	\$3,22

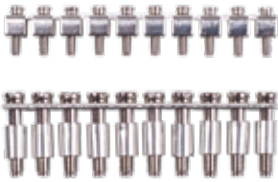

DURDURUCU

Referans No	Açıklama	Kutu / Koli	Birim Fiyatı (\$)
E/FJ	Vidalı	100/2000	\$0,38
E/117	Yaylı	100/1600	\$0,62



KLEMENS İŞARETLEME

Referans No	Açıklama	Kutu / Koli	Birim Fiyatı (\$)
ZBS	Etiket	1/100	\$0,27
ZB5	Etiket	1/100	\$0,27
ZB6	Etiket	1/100	\$0,27
ZB8	Etiket	1/100	\$0,27
ZB10	Etiket	1/100	\$0,27

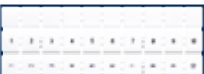

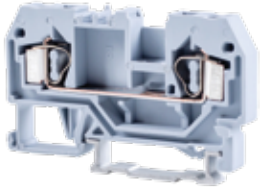

RAY KLEMENS YAY BASKILI

Referans No	Açıklama	Renk	Kutu / Koli	Birim Fiyatı (\$)
FJ1-2.5	2,5 mm ²	●●●●●●	100/2100	\$0,49
FJ1-4	4 mm ²	●●●●●●	75/1575	\$0,77
FJ1-6	6 mm ²	●●●●●●	45/945	\$1,18
FJ1-10	10 mm ²	●●●●●●	25/550	\$1,96

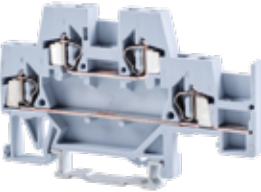

RAY KLEMENS ÇİFT KATLI YAYLI

Referans No	Açıklama	Renk	Kutu / Koli	Birim Fiyatı (\$)
FJ1-2.5K	2,5 mm ²	●●●●●●	100/1200	\$1,29
FJ1-4K	4 mm ²	●●●●●●	80/960	\$1,60

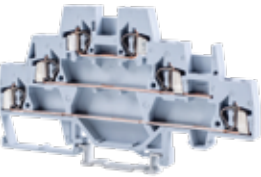

RAY KLEMENS ÜÇ KATLI YAYLI

Referans No	Açıklama	Renk	Kutu / Koli	Birim Fiyatı (\$)
FJ1-2.5KK	2,5 mm ²	●	55/1110	\$2,64



TOPRAKLAMA KLEMENS YAY BASKILI

Referans No	Açıklama	Renk	Kutu / Koli	Birim Fiyatı (\$)
FJ1-2.5/D	2,5 mm ²	●	60/1800	\$1,81
FJ1-4/D	4 mm ²	●	50/1700	\$2,41
FJ1-6/D	6 mm ²	●	40/1200	\$3,07

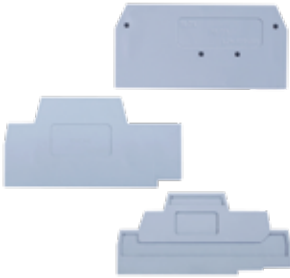

KLEMENS KAPAĞI

Referans No	Açıklama	Kutu / Koli	Birim Fiyatı (\$)
P9/2.5	Yaylı 2.5 mm ² için	100	\$0,29
P9/4	Yaylı 4 mm ² için	100	\$0,31
P9/6	Yaylı 6 mm ² için	100	\$0,34
P9/10	Yaylı 10 mm ² için	100	\$0,38
P9/2.5K	Yaylı İki katlı 2.5 mm ² için	100	\$0,32
P9/4K	Yaylı İki katlı 4 mm ² için	100	\$0,39
P9/2.5KK	Yaylı Üç Katlı 2.5 mm ² için	100	\$0,66

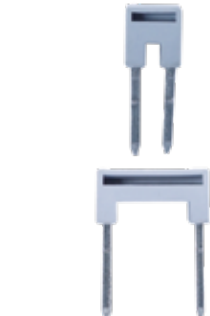

ÜST KÖPRÜ YAY BASKILI KLEMESLER İÇİN

Referans No	Açıklama	Kutu / Koli	Birim Fiyatı (\$)
T2.5	2,5mm ² için	100	\$0,39
T4	4 mm ² için	100	\$0,47
T6	6 mm ² için	100	\$0,63
T10	10 mm için	100	\$0,94
H2.5	2,5mm ² için	100	\$0,58
H4	4 mm ² için	100	\$0,78
H6	6 mm ² için	100	\$1,16
H10	10 mm için	100	\$1,30



TB 1500 SERİSİ KLEMENSLER

Referans No	Açıklama	Akım(A)	Kutup	Kutu / Koli	Birim Fiyatı (\$)
TB-1503	0.5-1.5mm ²	15	3P	50/750	\$0,54
TB-1504	0.5-1.5mm ²	15	4P	50/750	\$0,63
TB-1505	0.5-1.5mm ²	15	5P	50/750	\$0,87
TB-1506	0.5-1.5mm ²	15	6P	50/750	\$0,98
TB-1508	0.5-1.5mm ²	15	8P	50/750	\$1,56
TB-1510	0.5-1.5mm ²	15	10P	50/750	\$1,97
TB-1512	0.5-1.5mm ²	15	12P	50/750	\$1,99



TB-1503



TB-1504



TB-1505



TB-1506



TB-1508



TB-1510



TB-1512



TB 2500 SERİSİ KLEMENSLER

Referans No	Açıklama	Akım(A)	Kutup	Kutu / Koli	Birim Fiyatı (\$)
TB-2503	0.5-2.5mm ²	25	3P	50/750	\$1,34
TB-2504	0.5-2.5mm ²	25	4P	50/750	\$1,79
TB-2505	0.5-2.5mm ²	25	5P	50/750	\$1,95
TB-2506	0.5-2.5mm ²	25	6P	50/750	\$2,18
TB-2508	0.5-2.5mm ²	25	8P	50/750	\$2,28
TB-2510	0.5-2.5mm ²	25	10P	50/750	\$2,44
TB-2512	0.5-2.5mm ²	25	12P	50/750	\$2,68



TB-2503



TB-2504



TB-2505



TB-2506



TB-2508



TB-2510



TB-2512

KOMPAKT KLEMENSLER

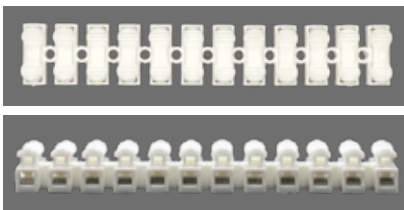

Referans No : MK-823-2.2-12P
 Açıklama : 12 Klemensli
 Kutu / Koli : 100/1000
 Fiyat : \$1,55



Referans No : MK-823-2.2-2P
 Açıklama : 2 Klemensli
 Kutu / Koli : 200/1000
 Fiyat : \$0,12

TANITIMA
 ÖZEL
 FİYAT

2 KUT.DAĞ.ÜN. 125 A



Referans No : FJ207/125BE
Açıklama : 2x7 Klemensli
Kutu / Koli : 2/138
Fiyat : \$5,95



Referans No : FJ211/125BE
Açıklama : 2x11 Klemensli
Kutu / Koli : 1/84
Fiyat : \$8,60



Referans No : FJ215/125BE
Açıklama : 2x15 Klemensli
Kutu / Koli : 1/72
Fiyat : \$11,25

4 KUT.DAĞ.ÜN. 125 A



Referans No : FJ407/125BE
Açıklama : 4x7 Klemensli
Kutu / Koli : 1/74
Fiyat : \$11,39



Referans No : FJ411/125BE
Açıklama : 4x11 Klemensli
Kutu / Koli : 1/50
Fiyat : \$16,59



Referans No : FJ415/125BE
Açıklama : 4x15 Klemensli
Kutu / Koli : 1/40
Fiyat : \$20,99

1 KUT.DAĞ.ÜN. 125 A



Referans No : FKG2/06S
Açıklama : 6 Klemensli
Kutu / Koli : 1/480
Fiyat : \$1,92



Referans No : FKG2/10S
Açıklama : 10 Klemensli
Kutu / Koli : 1/240
Fiyat : \$2,70



Referans No : FKG2/12S
Açıklama : 12 Klemensli
Kutu / Koli : 1/200
Fiyat : \$3,08



Referans No : FKG2/18S
Açıklama : 18 Klemensli
Kutu / Koli : 1/100
Fiyat : \$4,10

KOMPAKT KLEMENSLER



Referans No : FJ-402
Açıklama : İkili klemens
: Flexi 2,5mm²
: Tek tel 4 mm²
Kutu / Koli : 100/3600
Fiyat : \$0,251



Referans No : FJ-403
Açıklama : Üçlü klemens
: Flexi 2,5mm²
: Tek tel 4 mm²
Kutu / Koli : 60/2700
Fiyat : \$0,337



Referans No : FJ-405
Açıklama : Beşli Klemens
: Flexi 2,5mm²
: Tek tel 4 mm²
Kutu / Koli : 40/1000
Fiyat : \$0,513

İZOLELİ KABLO YÜKSÜKLERİ (Tek Girişli)

Referans No	F mm	L mm	W mm	B mm	D mm	C mm	A.W.G	MM2	Renk	Kutu / Koli	Birim Fiyatı (₺)
E0508	8	14	2,6	6	1,3	1	1,3	1,3	⊙	2.000	₺0,168
E7508	8	14,6	2,8	6,4	1,5	1,2	1,5	1,5	⊙	2.000	₺0,168
E1008	8	14,6	3	6,4	1,7	1,4	1,7	1,7	⊙	1.500	₺0,168
E1508	8	14,6	3,5	6,4	2	1,7	2	2	⊙	1.000	₺0,183
E2508	8	15,2	4	7	2,6	2,3	2,6	2,6	⊙	900	₺0,234
E4009	9	16,5	4,4	7,5	3,2	2,8	3,2	3,2	⊙	400	₺0,396
E6012	12	20	6,3	8,0	3,9	3,5	3,9	3,9	⊙	300	₺0,524
E10-12	12	21,5	7,6	9,5	4,9	4,5	4,9	4,9	⊙	200	₺0,663
E16-12	12	22,2	8,8	10,2	6,2	5,8	6,2	6,2	⊙	120	₺0,940
E25-16	16	29	11,2	13	7,9	7,5	7,9	7,9	⊙	65	₺1,580
E35-16	16	30	12,7	14	8,7	8,3	8,7	8,7	⊙	100	₺1,980

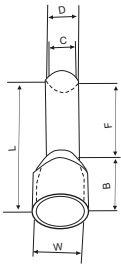

İZOLELİ KABLO YÜKSÜKLERİ (Çift Girişli)

Referans No	F mm	L mm	W mm	B mm	DQ mm	CQ mm	MM2	Renk	Kutu / Koli	Birim Fiyatı (₺)
TE-0508	8	14,5	5	6,5	1,8	1,5	2x0,5	⊙	1.000	₺0,297
TE-7508	8	14,7	5,5	6,7	2,1	1,8	2x0,75	⊙	800	₺0,311
TE-1008	8	15,1	5,5	7,1	2,3	2	2x1	⊙	500	₺0,335
TE-1508	8	15,5	6,4	7,2	2,6	2,3	2x1,5	⊙	500	₺0,400
TE-2510	10	18,5	8	8,5	3,3	2,9	2x2,5	⊙	300	₺0,653
TE-4012	12	23,1	8,8	11,1	4,2	3,8	2x4	⊙	200	₺0,752
TE-6014	14	26,1	9,5	12,1	5,3	4,9	2x6	⊙	150	₺0,930

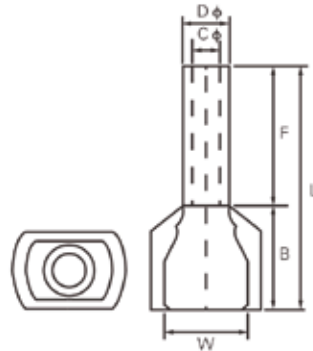

İZOLELİ KABLO UÇLARI

Referans No	Bold Size	Çap D2	B mm	L mm	F mm	H mm	DQ mm	Renk	Kutu / Koli	Birim Fiyatı (₺)
RV1.25-3.2	M3	3,2mm	5,7	18,3	5,0	10,5	4,3	☉	300	₺ 0,535
RV1.25-3.5S	M3	3,7mm	5,7	18,3	5,0	10,5	4,9	☉	300	₺ 0,535
RV1.25-3.5M	M3	3,7mm	6,6	20,6	6,3	10,5	4,9	☉	300	₺ 0,535
RV1.25-3.5L	M3	3,7mm	8,0	22,0	7,0	10,5	4,9	☉	300	₺ 0,535
RV1.25-4S	M4	4,3mm	6,6	21,6	6,3	10,5	4,9	☉	300	₺ 0,792
RV1.25-4L	M4	4,3mm	8,0	22,0	7,0	10,5	4,9	☉	300	₺ 0,792
RV1.25-5	M5	5,3mm	8,0	22,0	7,0	10,5	4,9	☉	300	₺ 0,801
RV1.25-6	M6	6,5mm	11,6	28,0	11,1	10,5	4,9	☉	200	₺ 1,250
RV1.25-8	M8	8,4mm	11,6	28,0	11,1	10,5	4,9	☉	200	₺ 1,280



0,5 - 1,5mm²
Kablo Kesiti



1,5 - 2,5mm²
Kablo Kesiti



4,0 - 6,0mm²
Kablo Kesiti

RV2-3.2	M3	3,2mm	6,6	19,5	5,7	10,5	4,9	☉	300	₺ 0,970
RV2-4S	M4	4,3mm	6,6	22,0	8,5	10,5	4,9	☉	300	₺ 0,970
RV2-5S	M5	5,3mm	9,5	23,0	7,25	10,5	4,9	☉	250	₺ 0,990
RV2-6L	M5	6,5mm	12,0	28,1	11,0	10,5	4,9	☉	250	₺ 1,405
RV2-8	M8	10,5mm	13,6	30,7	13,9	10,5	4,9	☉	200	₺ 1,405
RV2-10S	M10	10,5mm	17,5	34,5	15,2	10,5	4,9	☉	200	₺ 1,435

RV5.5-4S	M4	4,3mm	7,2	22,4	5,9	10,5	4,9	☉	200	₺ 2,050
RV5.5-4L	M4	4,3mm	9,5	26,5	8,3	10,5	4,9	☉	150	₺ 2,050
RV5.5-5	M5	5,3mm	9,5	26,5	8,3	10,5	4,9	☉	200	₺ 2,050
RV5.5-6	M6	6,5mm	12,0	32,5	13,0	10,5	4,9	☉	100	₺ 2,306
RV5.5-8	M8	8,4mm	15,0	34,7	13,7	10,5	4,9	☉	100	₺ 2,350
RV5.5-10	M10	10,5mm	15,0	34,7	13,7	10,5	4,9	☉	100	₺ 2,920
RV5.5-12	M12	13,0mm	19,2	39,1	16,0	10,5	4,9	☉	100	₺ 3,020

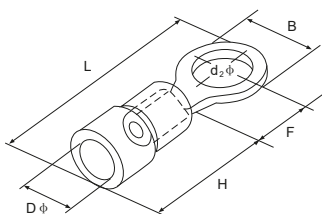

0,5 - 1,5mm²
Kablo Kesiti1,5 - 2,5mm²
Kablo Kesiti4,0 - 6,0mm²
Kablo Kesiti

İZOLELİ KABLO UÇLARI

Referans No	Bold Size	Çap D2	B mm	L mm	F mm	H mm	DQ mm	Renk	Kutu / Koli	Birim Fiyatı (₺)
SV1.25-4S	M4	4,3mm	6,4	21,8	6,5	10,5	4,3	🔴	300	₺0,557
SV1.25-5S	M5	5,3mm	8,1	21,8	6,5	10,5	4,3	🔴	300	₺0,752
SV1.25-6S	M6	6,5mm	9,5	21,8	6,5	10,5	4,3	🔴	300	₺0,851
SV1.25-8	M8	8,5mm	14,5	25,8	12,55	10,5	4,3	🔴	250	₺0,868
SV2-3.2	M3	3,2mm	5,7	21,8	6,5	10,5	4,9	🔵	300	₺0,782
SV2-3.5L	M3	3,7mm	6,0	21,8	6,5	10,5	4,9	🔵	300	₺0,801
SV2-4M	M4	4,3mm	7,2	21,8	6,5	10,5	4,9	🔵	250	₺0,801
SV2-4L	M4	4,3mm	8,1	21,8	6,5	10,5	4,9	🔵	250	₺0,801
SV2-5S	M5	5,3mm	8,1	21,8	6,5	10,5	4,9	🔵	250	₺0,811
SV2-5L	M5	5,3mm	9,5	21,8	6,5	10,5	4,9	🔵	300	₺0,811
SV2-6S	M6	6,5mm	9,5	21,8	6,5	10,5	4,9	🔵	200	₺1,090
SV2-6L	M6	6,5mm	12,0	27,8	11,0	10,5	4,9	🔵	200	₺1,090
SV5.5-4S	M4	4,3mm	8,3	26,2	7,5	13,5	6,7	🟡	200	₺1,792
SV5.5-4L	M4	4,3mm	9	24,9	7,5	13,5	6,7	🟡	180	₺1,792
SV5.5-5	M5	5,3mm	5,5	24,9	7,5	13,5	6,7	🟡	150	₺1,802
SV5.5-6S	M6	6,5mm	9	24,9	7,5	13,5	6,7	🟡	200	₺2,445
SV5.5-6L	M6	6,5mm	12	32,2	12	13,5	6,7	🟡	140	₺2,445
SV5.5-8	M8	8,4mm	14	8,31	11,5	13,5	6,7	🟡	100	₺2,772

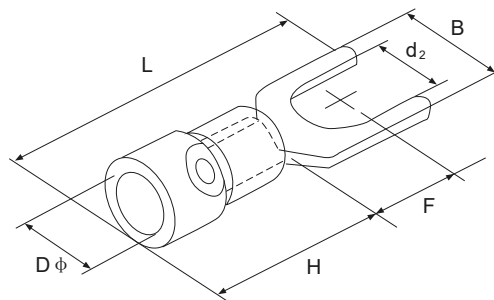



0,5 - 1,5mm²
Kablo Kesiti



1,5 - 2,5mm²
Kablo Kesiti



4,0 - 6,0mm²
Kablo Kesiti

İZOLELİ KABLO UÇLARI ERKEK

Referans No	Kalınlık mm	bQ mm	F mm	DQ mm	dQ mm	H mm	L mm	Renk	Kutu / Koli	Birim Fiyatı (₺)
MPD1.25-156	0,4	4,0	11,0	3,8	1,7	10,0	21,0	🔴	300	₺1,881

MPD2-156	0,4	4,0	11,0	4,3	2,3	10,0	21,0	🔵	300	₺2,079
----------	-----	-----	------	-----	-----	------	------	---	-----	--------

MPD2-195	0,4	5,0	11,0	4,3	2,3	10,0	21,0	🔵	300	₺2,079
----------	-----	-----	------	-----	-----	------	------	---	-----	--------

MPD5.5-195	0,4	5,0	11,0	5,7	3,4	12,5	25,0	🟡	300	₺2,821
------------	-----	-----	------	-----	-----	------	------	---	-----	--------

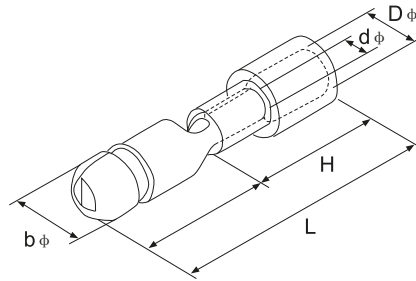

İZOLELİ KABLO UÇLARI DIŞI

Referans No	Kalınlık mm	bQ mm	F mm	DQ mm	dQ mm	H mm	L mm	Renk	Kutu / Koli	Birim Fiyatı (₺)
FRD1.25-156	0,4	4,0	6,3	3,8	1,7	13,0	24,5	🔴	100	₺2,227

FRD2-156	0,4	4,0	6,3	4,3	2,3	14,0	24,5	🔵	100	₺2,475
----------	-----	-----	-----	-----	-----	------	------	---	-----	--------

FRD2-195	0,4	5,0	7,0	4,3	2,3	14,0	24,5	🔵	100	₺2,475
----------	-----	-----	-----	-----	-----	------	------	---	-----	--------

FRD5.5-195	0,4	4,0	6,3	4,3	2,3	14,0	24,5	🟡	100	₺3,069
------------	-----	-----	-----	-----	-----	------	------	---	-----	--------

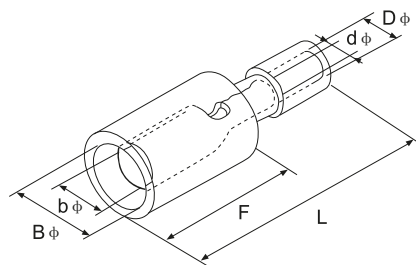

0,5 - 1,5mm²
Kablo Kesiti



1,5 - 2,5mm²
Kablo Kesiti



4,0 - 6,0mm²
Kablo Kesiti

İZOLELİ KABLO UÇLARI DIŞI

Referans No	Kalınlık mm	B mm	dQ mm	DQ mm	H mm	L mm	Renk	Kutu / Koli	Birim Fiyatı (₺)
FDD1.25-110(8)	0,3	3,8	1,7	3,8	10,0	19,0	🔴	300	₺0,545
FDD1.25-187(5)	0,35	5,6	1,7	3,8	10,0	19,0	🔴	300	₺0,653
FDD1.25-187(8)	0,35	5,6	1,7	3,8	10,0	19,0	🔴	300	₺0,653
FDD1.25-250	0,4	7,4	1,7	3,8	10,0	21,0	🔴	300	₺0,841
FDD2-110(8)	0,3	3,8	2,3	4,3	10,0	19,0	🔵	300	₺0,653
FDD2-187(8)	0,35	5,6	2,3	4,3	10,0	19,0	🔵	300	₺0,742
FDD2-250	0,4	7,4	2,3	4,3	10,0	21,0	🔵	300	₺0,841
FDD5.5-250	0,4	7,4	3,4	5,7	12,5	25,0	🟡	200	₺1,039

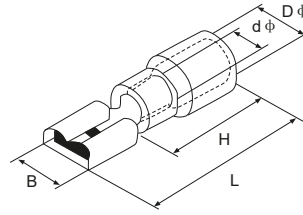
0,5 - 1,5mm²
Kablo Kesiti1,5 - 2,5mm²
Kablo Kesiti4,0 - 6,0mm²
Kablo Kesiti

İZOLELİ KABLO UÇLARI ERKEK

Referans No	Kalınlık mm	B mm	dQ mm	DQ mm	H mm	L mm	Renk	Kutu / Koli	Birim Fiyatı (₺)
MDD1.25-110(8)	0,8	2,8	1,7	3,8	10,0	17,7	🔴	300	₺0,594
MDD1.25-187(5)	0,5	4,75	1,7	3,8	10,0	20,0	🔴	300	₺0,594
MDD1.25-187(8)	0,5	4,75	1,7	3,8	10,0	20,0	🔴	300	₺0,594
MDD1.25-250	0,4	6,35	1,7	3,8	10,0	21,0	🔴	300	₺0,703
MDD2-110(8)	0,5	4,8	2,3	4,3	10,0	20,0	🔵	300	₺0,594
MDD2-187(5)	0,5	4,8	2,3	4,3	10,0	20,0	🔵	300	₺0,594
MDD2-250	0,4	6,35	2,3	4,3	10,0	21,0	🔵	300	₺0,772
MDD5.5-250	0,4	6,4	3,4	5,7	12,5	25,0	🟡	200	₺0,920

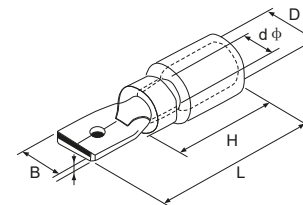
0,5 - 1,5mm²
Kablo Kesiti1,5 - 2,5mm²
Kablo Kesiti4,0 - 6,0mm²
Kablo Kesiti



0,5 - 1,5mm²
Kablo Kesiti



1,5 - 2,5mm²
Kablo Kesiti



4,0 - 6,0mm²
Kablo Kesiti

İZOLELİ KABLO UÇLARI DIŞI

Referans No	Kalınlık mm	W mm	B mm	DQ mm	dQ mm	L mm	Renk	Kutu / Koli	Birim Fiyatı (₺)
DFD1.25-187(5)	0,5	7,6	5,6	3,8	1,7	20,0	🔴	200	₺0,861
DFD1.25-250	0,8	9,4	7,4	3,8	1,7	21,5	🔴	150	₺1,138
DFD2-187(5)	0,5	7,6	5,6	4,3	2,3	20,0	🔵	200	₺0,871
DFD2-250	0,8	9,4	7,4	4,3	2,3	21,5	🔵	150	₺1,138
DFD5.5-250	0,8	9,4	7,4	5,7	3,4	25,5	🟡	150	₺1,237

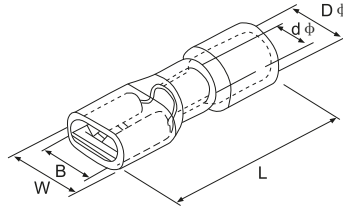

İZOLELİ KABLO MUFLARI DIŞI

Referans No	Kalınlık mm	W mm	DQ mm	L mm	Max A	Renk	Kutu / Koli	Birim Fiyatı (₺)
BV 1.25	0,5~1,5	15,0	4,4	26,0	19,0	🔴	300	₺1,089
BV 2	1,5~2,5	15,0	5,1	26,0	27,0	🔵	150	₺1,138
BV 5.5	4~6	15,0	6,8	26,0	48,0	🟡	100	₺1,881



0,5 - 1,5mm²
Kablo Kesiti



1,5 - 2,5mm²
Kablo Kesiti



4,0 - 6,0mm²
Kablo Kesiti

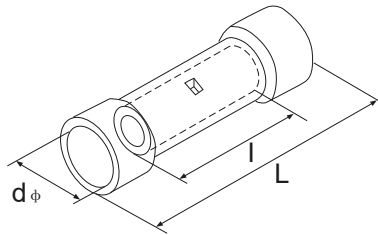



0,5 - 1,5mm²
Kablo Kesiti



1,5 - 2,5mm²
Kablo Kesiti



4,0 - 6,0mm²
Kablo Kesiti

İZOLELİ KABLO UÇLARI DIŞI

Referans No	FQ mm	L mm	H mm	DQ mm	Renk	Kutu / Koli	Birim Fiyatı (₺)
PTV 1.25-10	1,9	20	10	4,3	☉	300	₺ 0,822
PTV 1.25-13	1,9	33	10	4,3	☉	300	₺ 0,822
PTV 2-10	1,9	20	10	4,9	☉	300	₺ 0,990
PTV 2-12	1,9	22	10	4,9	☉	300	₺ 0,990
PTV 5.5-13	2,8	25,5	12,5	6,7	☉	200	₺ 2,376

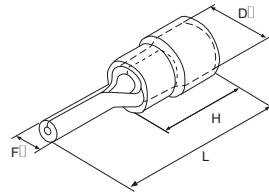

YUVARLAK AÇIK KABLO UÇLARI

Referans No	Kablo	D mm	W mm	E mm	Kalınlık	Kutu / Koli	Birim Fiyatı (₺)
DJ431-3A	0,5 - 0,8	3,5	9,0	17,0	0,5	200	₺ 0,750
DJ431-5A	0,5 - 0,8	5,2	10,0	17,0	0,5	200	₺ 0,950
DJ431-6A	0,5 - 0,8	6,2	12,0	17,0	0,5	300	₺ 1,250



YUVARLAK KAPALI KABLO UÇLARI

Referans No	d2 iç mm	B Dış mm	L mm	F mm	E mm	dQ mm	DQ mm	Kutu / Koli	Birim Fiyatı (₺)
RNBL 1.25-4	4,3	8	15,8	7	4,8	3,4	1,7	1.500	₺ 1,950
RNBL 2-5	5,3	9,5	16,8	7,25	4,8	4,1	2,3	1.000	₺ 2,350
RNBL 3.5-6	6,4	12	21,4	7,7	6	5	3	1.000	₺ 2,750

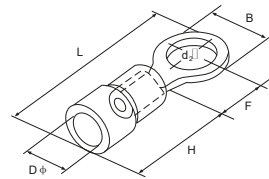

DIŞI KABLO UÇLARI

Referans No	Kablo	D mm	W mm	E mm	Kalınlık	Kutu / Koli	Birim Fiyatı (₺)
DJ622-A6.3B	1,0 - 1,5	7,7	18,5	7,5	0,4	200	₺ 1,550



DIŞI KABLO UÇLARI

Referans No	B mm	dQ mm	DQ mm	L mm	Kutu / Koli	Birim Fiyatı (₺)
FDN1.25-250	1,0 - 1,5	3,8	1,7	21	700	₺ 1,550

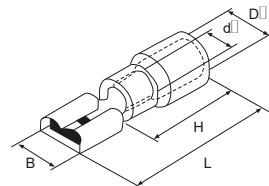

0,5~1,5 mm² İzoleli Kablo Uçları (Amerikan Standardı 22~16) Max. Akım = 19A

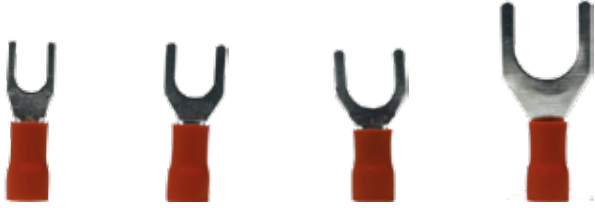

SV1.25-4S SV1.25-5S SV1.25-6S SV1.25-8

1,5~2,5 mm² İzoleli Kablo Uçları (Amerikan Standardı 16~14) Max. Akım = 27A



SV2-3.2 SV2-3.5L SV2-4M SV2-4L SV2-5S SV2-5L SV2-6S SV2-6L

4~6 mm² İzoleli Kablo Uçları (Amerikan Standardı 12~10) Max. Akım=48A



SV5.5-4S SV5.5-4L SV5.5-5 SV5.5-6S SV5.5-6L SV5.5-8

0,5~1,5 mm² İzoleli Kablo Uçları (Amerikan Standardı 22~16) Max. Akım=19A



RV1.25-3.2 RV1.25-3.5S RV1.25-3.5M RV1.25-3.5L RV1.25-4S RV1.25-4L RV1.25-5 RV1.25-6 RV1.25-8

1,5~2,5 mm² İzoleli Kablo Uçları (Amerikan Standardı 16~14) Max. Akım = 27A



RV2-3.2 RV2-4S RV2-5S RV2-5L RV2-8 RV2-10S

4~6 mm² İzoleli Kablo Uçları (Amerikan Standardı 12~10) Max. Akım=48A



RV5.5-4S RV5.5-4L RV5.5-5 RV5.5-6 RV5.5-8 RV5.5-10 RV5.5-12

İzoleli Tek Girişli Kablo Yüksükleri

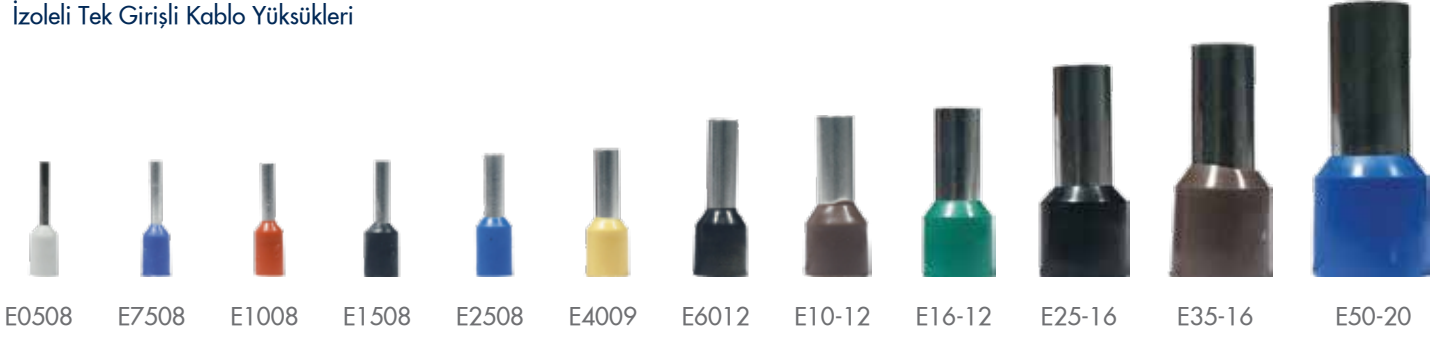

İzoleli Çift Girişli Kablo Yüksükleri



İzoleli Kablo Uçları



İzoleli Kablo Uçları



İzoleli Kablo Uçları

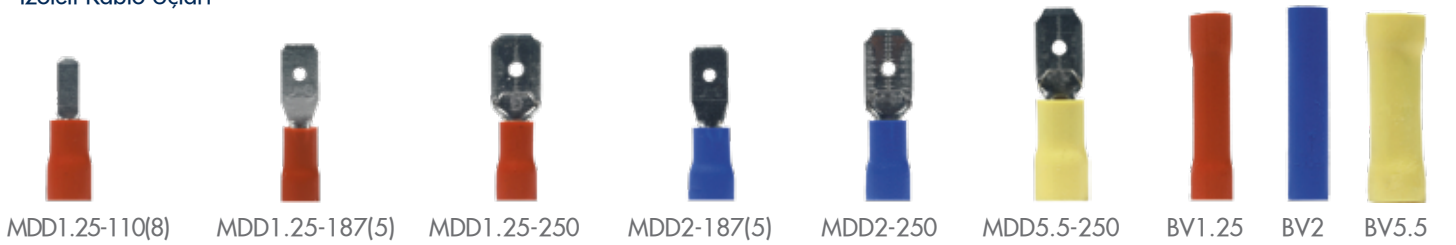

İzoleli Kablo Uçları



GLORIOUS®

NOTLAR

A series of horizontal dashed blue lines for writing notes, spanning the width of the page.

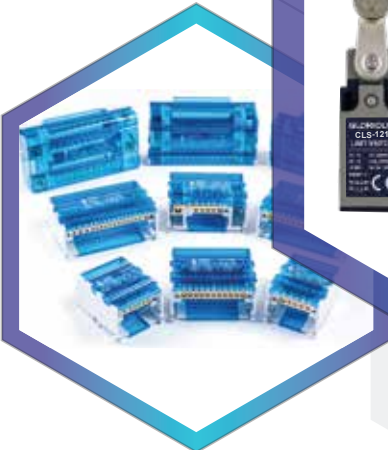

TUĞBA ELEKTRİK SAN. TİC. LTD. ŞTİ.

Perpa Ticaret Merkezi A Blok Kat: 8 No: 731 Okmeydanı - Şişli / İSTANBUL

Tel : +90 212 320 94 57 • Fax: +90 212 320 56 84

Web: www.tugbaelektrik.com • E-Mail: tugbaelektrik@gmail.com