



Kıvılcım Elektrik

JAMESON®

Yeni Nesil Teknoloji...

www.kivilcimelektrik.com.tr

Whatsapp Sipariş Hattı: [0531 727 74 64](https://www.whatsapp.com/business/contact?phone=905317277464) 

2022 EKİM

İÇİNDEKİLER

KABLO BAĞLARI VE AKSESUARLARI

Standart Beyaz Kablo Bağları	6
Standart Siyah Kablo Bağları	7
Standart Renkli Kablo Bağları	8
Ultraviole Kablo Bağları	9
Boncuk Kablo Bağları	9
Paslanmaz Çelik Kablo Bağları	10
Paslanmaz Çelik Etiket	10
PVC Kaplı Paslanmaz Çelik Kablo Bağları	11
Etiketli Kablo Bağları	12
Açılabilir Kablo Bağları	12
Distanslı Kablo Bağları	12
Yapışkanlı Kroşeler	13
Kapama Parçası	13
Kablo Kelepçesi	13
Kartuş Yükseltici	14
Beton Kroşe	14
Vidalı Kroşe	14
Kablo Bağı Etiket Taşıyıcı	15
Yapışkanlı Pano Etiket Taşıyıcı	15
Kablo İşaretleme Sistemleri	15
Helezon Spiraller	16

KABLO YÜKSÜKLERİ

İzoleli Kablo Yüksükleri Fransız Normu	18
İzoleli Kablo Yüksükleri Alman Normu	19
Çift Girişli Kablo Yüksükleri Fransız Normu	20
Çift Girişli Kablo Yüksükleri Alman Normu	21
İzolesiz Kablo Yüksükleri	22

KABLO UÇLARI

Yuvarlak Tip İzoleli Kablo Uçları	24
Çatal Tip İzoleli Kablo Uçları	25
Ek Mufları İzoleli Kablo Uçları	26
Erkek Terminaller İzoleli Kablo Uçları	26
Dişi Terminaller İzoleli Kablo Uçları	26
Dişi Faston Tip İzoleli Kablo Uçları	27
Tam İzoleli Dişi Faston Tip Kablo Uçları	27
Tam İzoleli Polyamid Dişi Faston Tip Kablo Uçları	27

İğne Tip İzoleli Kablo Uçları	28
Erkek/Dişi Geri Dönümlü Terminaller	28
Tam İzoleli Polyamid Bayrak Tip Terminaller	28
Erkek Faston Tip Kablo Uçları	29
Vidalı Buat Klemensleri	29
Hızlı Kablo Ekleme Parçası	29
İzolesiz Kablo Ucu ve Konnektörleri	30

BAĞLANTI ELEMANLARI

SKP-E Ekonomik Tip Kablo Pabucu	32
SKP-S Standart Tip Kablo Pabucu	33
Ek Mufları	34
U Klemens	35
Monofaze Müşterek W Otomat Barları	36
Trifaze Müşterek W Otomat Barları	36
Montaj Rayları	37
Nötr Topraklama Baralar	37
Raya Montajlı Priz	37
Eriyen Bantlar	38
Pvc İzole Bant	38
Jks Serisi Kapı Siviçleri	38
2 Kutuplu Dağıtıcı Üniteler	39
4 Kutuplu Dağıtıcı Üniteler	40
Tek Kutuplu Dağıtıcı Üniteler	41-42

ÇOK AMAÇLI KLEMENSLER

Geçmeli Buat Klemens	44
Çok Amaçlı Klemens	44

MAKARON ÇEŞİTLERİ

Isı İle Daralan Siyah Makaronlar	46
Isı İle Daralan Renkli Makaronlar	47-48
Isı İle Daralan Makaronlar	49
İçi Yapışkanlı Boru Tipi Makaronlar	50
H Class Cam Elyaf Silikon İzoleli Makaronlar	51
PVC İzoleli Cam Elyaf Makaronlar	52

KABLO TOPLAMA ÇORABI VE BANT ÇEŞİTLERİ

Kablo Toplama Çorabı	54
----------------------	----

MEKANİK VE HİDROLİK EL ALETLERİ

Yüksük Sıkma Penseleri/Mekanik El Aletleri	56
Kablo Sıyırıcıları/Mekanik El Aletleri	58
Kablo Kesme Makasları	59-60
Kablo Pabucu Mekanik ve Hidrolik Sıkma Penseleri	61-62

BUTON VE AKSESUARLARI

Yaylı Butonlar	64
İkiz Butonlar	64

Q 22mm Buton Serisi

Kalıcı Mandal Butonlar	65
Kayıcı Kandal Butonlar	65
Anahtarlı Kalıcı & Kayıcı Butonlar	65
Joystick Vinç Butonları	65
Q22mm Buton Serisi	66
40 mm Kalıcı Mantar Butonlar	67
40 mm Kalıcı Anahtarlı Mantar Buton	67
40 mm Kayıcı Mantar Butonlar	67
40 mm Kalıcı Mantar Butonlar	67
Buton Aksesuarları	68
Boş Buton Kutuları	69
Kutulu Acil Stop Buton	69
ø 22mm Voltmetre	70
ø 22mm Ampermetre	70
ø 22mm Ledli Sinyaller	71
ø 16mm Ledli Sinyaller	71
BA9S Led Ampuller	72
Metal Ledli Sinyaller	73

Buzzerlar

ø 22mm Ledli Buzzer	74
ø 22mm Sesli Buzzer	74
Motorlu Sirenler	74
Elektronik Sirenler	75
ø 22mm Potansiyometre	75
Pano İçi Termostatlar	75

Vinç Kumanda Butonları

Plastik Vinç Kumandalar (IP67)	76
Acil Stoplu Plastik Vinç Kumandalar (IP67)	76
Ayak Pedalları	77

SWITCH ÇEŞİTLERİ

JLS Serisi Limit Switch	79-82
JMZ Serisi Mikro Switch	83-85
JMS Serisi Mikro Switch	86

FAN ÇEŞİTLERİ

Fanlar	88
Fan Filtreleri	88
Fan Koruma Telleri	88

Dikkat !

Bu fiyat listesindeki tipografik baskı hatalarından firmamız sorumlu değildir. Firmamız fiyat listesinde yayınlanmış olduğu teknik özellikleri değiştirme, döviz ve hammadde artışlarından dolayı meydana gelebilecek fiyat artışlarını hiçbir uyarıda bulunmaksızın fiyat listesine yansıtma hakkına sahiptir.

JAMESON®



KABLO BAĞLARI VE AKSESUARLAR



www.kivilcimelektrik.com.tr

STANDART BEYAZ KABLO BAĞLARI

Sipariş Kodu	Ürün Kodu	Boyutlar		Renk	Maksimum Sıkma Çapı (mm)	Açıklama Mukavemeti (kg)	Ambalaj Adet		Birim Fiyat TL / Adet
		Uzunluk (mm)	En (mm)				Paket	Koli	
3001	JKB-2510B	100		Beyaz	20		100	50.000	0,150
3002	JKB-2515B	150	2.5	Beyaz	36	8	100	40.000	0.239
3003	JKB-2520B	200		Beyaz	52		100	30.000	0.340
3004	JKB 3615B	150		Beyaz	36		100	30.000	0.405
3005	JKB 3620B	200		Beyaz	52		100	20.000	0.522
3006	JKB-3625B	250	3.6	Beyaz	68	18	100	20.000	0.635
3007	JKB-3630B	300		Beyaz	84		100	17.000	0.800
3008	JKB-3637B	370		Beyaz	106		100	12.000	1.000
3009	JKB-4820B	200		Beyaz	50		100	16.000	0.750
3010	JKB-4825B	250		Beyaz	65		100	12.000	0.910
3011	JKB-4830B	300	4.8	Beyaz	81	22	100	11.000	1.100
3012	JKB-4837B	370		Beyaz	104		100	9.000	1.250
3013	JKB-4843B	430		Beyaz	123		100	7.500	1.705
3014	JKB-4855B	550		Beyaz	160		100	5.000	2.275
3015	JKB-7630B	300		Beyaz	76		100	5.000	2.160
3016	JKB-7637B	370		Beyaz	102		100	4.000	2.400
3017	JKB-7645B	430	7.6	Beyaz	110	55	100	2.500	2.782
3018	JKB-7655B	530		Beyaz	140		100	2.000	3.700
3019	JKB-7661B	610		Beyaz	185		100	2.000	4.150
3020	JKB-7675B	750		Beyaz	226		100	2.000	5.750
3022	JKB-9710B	710		Beyaz	190		100	2.000	6.270
3023	JKB-9780B	780		Beyaz	228		100	2.000	7.500
3024	JKB-9920B	920	9	Beyaz	280	80	100	1.000	8.530
3025	JKB-91020B	1020		Beyaz	295		100	1.000	9.000
3026	JKB-91220B	1220		Beyaz	375		100	1.000	11.130

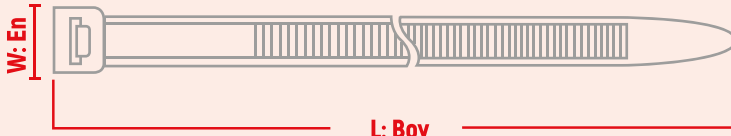

MALZEME: Saf Nylon 6.6 Standart UL
ÇALIŞMA SICAKLIĞI: -40 °C - +85 °C



STANDART SİYAH KABLO BAĞLARI

Sipariş Kodu	Ürün Kodu	Boyutlar		Renk	Maksimum Sıkma Çapı (mm)	Açıklama Mukavemeti (kg)	Ambalaj Adet		Birim Fiyat TL / Adet
		Uzunluk (mm)	En (mm)				Paket	Koli	
3027	JKB-2510S	100		Siyah	20		100	70.000	0,150
3028	JKB-2515S	150	2.5	Siyah	36	8	100	55.000	0.239
3029	JKB-2520S	200		Siyah	52		100	32.000	0.340
3030	JKB-3615S	150		Siyah	36		100	30.000	0.405
3031	JKB-3620S	200		Siyah	52		100	20.000	0.522
3032	JKB-3625S	250	3.6	Siyah	68	18	100	20.000	0.635
3033	JKB-3630S	300		Siyah	84		100	17.000	0.800
3034	JKB-3637S	370		Siyah	106		100	12.000	1.000
3035	JKB-4820S	200		Siyah	50		100	16.000	0.750
3036	JKB-4825S	250		Siyah	65		100	12.000	0.910
3037	JKB-4830S	300	4.8	Siyah	81	22	100	11.000	1.100
3038	JKB-4837S	370		Siyah	104		100	9.000	1.250
3039	JKB-4843S	430		Siyah	123		100	7.500	1.705
3040	JKB-4855S	550		Siyah	160		100	5.000	2.275
3041	JKB-7630S	300		Siyah	76		100	5.000	2.160
3042	JKB-7637S	370		Siyah	102		100	4.000	2.400
3043	JKB-7645S	430	7.6	Siyah	110	55	100	2.500	2.782
3044	JKB-7655S	530		Siyah	140		100	2.000	3.700
3045	JKB-7661S	610		Siyah	185		100	2.000	4.150
3046	JKB-7675S	750		Siyah	226		100	2.000	5.750
3047	JKB-9710S	710		Siyah	190		100	2.000	6.270
3048	JKB-9780S	780		Siyah	228		100	2.000	7.500
3049	JKB-9920S	920	9	Siyah	280	80	100	1.000	8.530
3050	JKB-91020S	1020		Siyah	295		100	1.000	9.000
3051	JKB-91220S	1220		Siyah	375		100	1.000	11.130

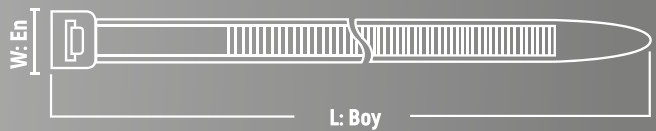

MALZEME: Saf Naylon 6.6 Standart UL
ÇALIŞMA SICAKLIĞI: -40 °C - +85 °C



STANDART RENKLİ KABLO BAĞLARI

Sipariş Kodu	Ürün Kodu	Boyutlar		Renk	Maksimum Sıkma Çapı (mm)	Açıklama Mukavemeti (kg)	Ambalaj Adet		Birim Fiyat TL / Adet
		Uzunluk (mm)	En (mm)				Paket	Koli	
3101	JKB-2510K	100	2.5	Kırmızı	20	8	100	70.000	0.175
3102	JKB-3615K	150			36		100	30.000	0.445
3103	JKB-3620K	200	3.6	Kırmızı	52	18	100	20.000	0.585
3104	JKB-3625K	250			68		100	20.000	0.715
3105	JKB-3630K	300			84		100	17.000	0.865
3106	JKB-4820K	200			50		100	16.000	0.815
3107	JKB-4825K	250	4.8	Kırmızı	65	22	100	12.000	0.995
3108	JKB-4830K	300			81		100	11.000	1.220
3109	JKB-4837K	370			101		100	9.000	1.420
3110	JKB-2510M	100	2.5		20	8	100	70.000	0.175
3111	JKB-3615M	150			36		100	30.000	0.445
3112	JKB-3620M	200	3.6		52	18	100	20.000	0.585
3113	JKB-3625M	250			68		100	20.000	0.715
3114	JKB-3630M	300		Mavi	84		100	17.000	0.865
3115	JKB-4820M	200			50		100	16.000	0.815
3116	JKB-4825M	250	4.8		65	22	100	12.000	0.995
3117	JKB-4830M	300			81		100	11.000	1.220
3118	JKB-4837M	370			101		100	9.000	1.420
3119	JKB-2510SR	100	2.5		20	8	100	70.000	0.175
3120	JKB-3615SR	150			36		100	30.000	0.445
3121	JKB-3620SR	200	3.6		52	18	100	20.000	0.585
3122	JKB-3625SR	250			68		100	20.000	0.715
3123	JKB-3630SR	300		Sarı	84		100	17.000	0.865
3124	JKB-4820SR	200			50		100	16.000	0.815
3125	JKB-4825SR	250	4.8		65	22	100	12.000	0.995
3126	JKB-4830SR	300			81		100	11.000	1.220
3127	JKB-4837SR	370			104		100	9.000	1.420
3128	JKB-2510Y	100	2.5		20	8	100	70.000	0.175
3129	JKB-3615Y	150			36		100	30.000	0.445
3130	JKB-3620Y	200	3.6		52	18	100	20.000	0.585
3131	JKB-3625Y	250			68		100	20.000	0.715
3132	JKB-3630Y	300		Yeşil	84		100	17.000	0.865
3133	JKB-4820	200			50		100	16.000	0.815
3134	JKB-4825Y	250	4.8		65	22	100	12.000	0.995
3135	JKB-4830Y	300			81		100	11.000	1.220
3136	JKB-4837Y	370			101		100	9.000	1.420

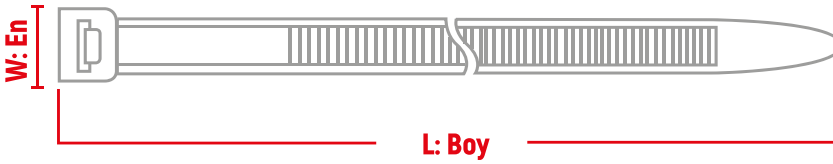

MALZEME: Saf Naylon 6.6 Standart UL
ÇALIŞMA SICAKLIĞI: -40 °C - +85 °C



ULTRAVIOLE KABLO BAĞLARI

Sipariş Kodu	Ürün Kodu	Boyutlar		Renk	Maksimum Sıkma Çapı (mm)	Açıklama Mukavemeti (kg)	Ambalaj Adet		Birim Fiyat TL / Adet
		Uzunluk (mm)	En (mm)				Paket	Koli	
3201	JKB-2510UV	100		Siyah	20		1.000	70.000	0.175
3202	JKB-2515UV	150	2.5	Siyah	36	8	1.000	55.000	0.268
3203	JKB-2520UV	200		Siyah	52		1.00	32.000	0.380
3204	JKB-3615UV	150		Siyah	36		100	30.000	0.438
3205	JKB-3620UV	200		Siyah	52		100	20.000	0.570
3206	JKB-3625UV	250	3.6	Siyah	68	18	100	20.000	0.690
3207	JKB-3630UV	300		Siyah	84		100	17.000	0.855
3208	JKB-3637UV	370		Siyah	50		100	16.000	1.100
3209	JKB-4820UV	200		Siyah	65		100	12.000	0.815
3210	JKB-4825UV	250		Siyah	81		100	11.000	0.990
3211	JKB-4830UV	300	4.8	Siyah	104	22	100	9.000	1.200
3212	JKB-4837UV	370		Siyah	123		100	7.500	1.430
3213	JKB-4843UV	430		Siyah	76		100	5.000	1.820
3214	JKB-4855UV	550		Siyah	102		100	4.000	2.350
3215	JKB-7630UV	300		Siyah	76		100	5.000	2.400
3216	JKB-7637UV	370	7.6	Siyah	102	55	100	4.000	2.550
3217	JKB-7645UV	430		Siyah	110		100	2.500	3.000
3218	JKB-7653UV	530		Siyah	140		100	2.000	3.980
3219	JKB-9710UV	710	9	Siyah	190	80	100	2.000	6.400
3220	JKB-9780UV	780		Siyah	228		100	2.000	8.650

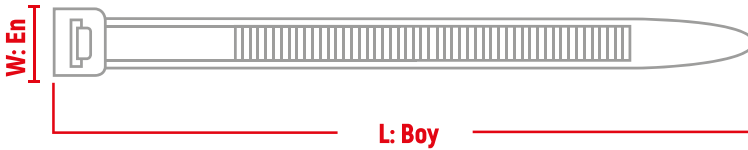

MALZEME: Saf Naylon 6.6 Standart UL
ÇALIŞMA SICAKLIĞI: -40 °C - +85 °C



BONCUK KABLO BAĞLARI

Sipariş Kodu	Ürün Kodu	Boyutlar		Maksimum Bağlama Çapı (mm)	Minimum Açma Kuvveti (kg)	Ambalaj Adet		Birim Fiyat TL / Adet
		Uzunluk (mm)	En (mm)			Paket	Koli	
3228	JBKB-2510	105	2	25	5	1.000	50.000	0.815
3229	JBKB-3517	165	3.5	45	7	500	25.000	1.135

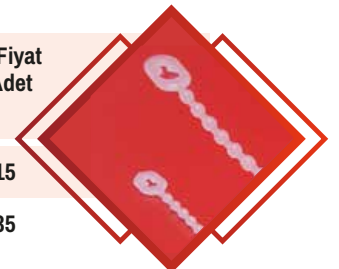

PASLANMAZ ÇELİK KABLO BAĞLARI

Sipariş Kodu	Ürün Kodu	Boyutlar		Renk	Maksimum Sıkma Çapı (mm)	Açıklama Mukavemeti (kg)	Ambalaj Adet		Birim Fiyat TL / Adet
		Uzunluk (mm)	En (mm)				Paket	Koli	
3301	JMT-4615	150	4.6	Metal	44	55	100	8.000	3.00
3302	JMT-4620	200		Metal	51		100	6.000	3.40
3303	JMT-4625	260		Metal	69		100	5.000	3.70
3304	JMT-4630	300		Metal	76		100	5.000	3.95
3305	JMT-4635	370		Metal	102		100	4.000	4.30
3306	JMT-4650	520		Metal	152		100	3.000	5.65
3307	JMT-4670	680		Metal	203		100	2.000	6.65
3308	JMT-4685	840		Metal	254		100	1.000	8.10
3309	JMT-7920	200	7.9	Metal	50	120	100	5.000	4.80
3310	JMT-7930	300		Metal	75		100	4.000	5.35
3311	JMT-7935	370		Metal	102		100	3.000	6.00
3312	JMT-7950	520		Metal	152		100	2.000	7.95
3313	JMT-7970	680		Metal	203		100	2.000	10.12
3314	JMT-7985	840		Metal	224		100	1.000	11.12



Malzeme : 304 Paslanmaz Çelik
Su emilimi : Yok
Alev yurmeme : UL94V-2

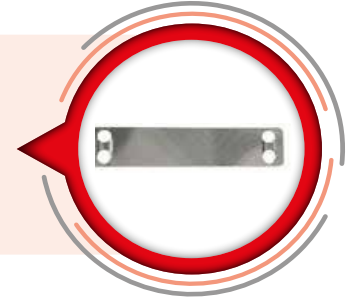

PASLANMAZ ÇELİK ETİKET

Sipariş Kodu	Ürün Kodu	Açıklama	Renk	Boy ve Genişlik (mm)	Ambalaj Adet	Birim Fiyat TL / Adet
1351	MTL PE	Paslanmaz Çelik Etiket	Metal	19 x 90	100	5.00

Paslanmaz Çelik Kablo Bağları

- Kendiliğinden kilitlenebilir kafa tasarımı, kurulumu hızlandırır ve kablo bağı gövdesi boyunca herhangi bir boyda kilitlemeyi sağlar.
- Güçlü ve dayanıklı kablo bağlama yöntemini temin eder.
- Çok çeşitli iç mekân ve dış mekân uygulama alanlarında kullanılabilir.
- Pürüzsüz yüzeyi ve yuvarlatılmış uçları ile kablonun korunmasını ve çalışan kişinin güvenliğini garanti eder.
- Genel amaçlı uygulamalar için : 304 paslanmaz çelik

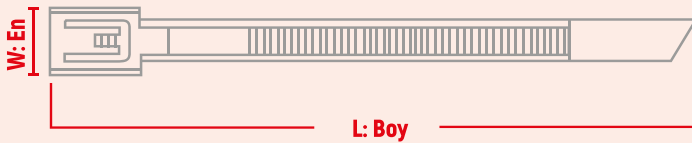

MALZEME: 304 Paslanmaz Çelik
SU EMİLİMİ: Yok
ALEV YÜRME: UL94V-2

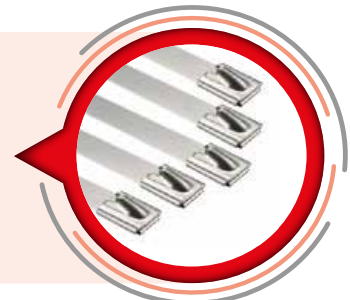

PVC KAPLI PASLANMAZ ÇELİK KABLO BAĞLARI

Sipariş Kodu	Ürün Kodu			Renk	Maksimum Sıkma Çapı (mm)	Açıklama Mukavemeti (kg)			Birim Fiyat TL / Adet
		Uzunluk (mm)	En (mm)				Paket	Koli	
3401	JMT-4615P	100	4.6	Metal	44	55	100	8.000	4.30
3402	JMT-4620P	200		Metal	51		100	6.000	4.80
3403	JMT-4625P	260		Metal	69		100	5.000	5.50
3404	JMT-4630P	300		Metal	76		100	5.000	5.22
3405	JMT-4635P	370		Metal	102		100	4.000	6.82
3406	JMT-4650P	520		Metal	152		100	3.000	8.75
3407	JMT-4670P	680		Metal	203		100	2.000	11.35
3408	JMT-4685P	840		Metal	254		100	1.000	13.70
3409	JMT-7920P	200	7.9	Metal	50	120	100	5.000	6.01
3410	JMT-7930P	300		Metal	75		100	4.000	7.30
3411	JMT-7935P	370		Metal	102		100	3.000	8.40
1312	JMT-7950P	520		Metal	152		100	2.000	11.10
3413	JMT-7970P	680		Metal	203		100	2.000	14.20
3414	JMT-7985P	840		Metal	224		100	1.000	19.10

PVC Kaplı Paslanmaz Çelik Kablo Bağları

- Kendiliğinden kilitlenebilir kafa tasarımı, kurulumu hızlandırır ve kablo bağı gövdesi boyunca herhangi bir boyda kilitlemeyi sağlar.
- Güçlü ve dayanıklı kablo bağlama yöntemini temin eder.
- Çok çeşitli iç mekân ve dış mekân uygulama alanlarında kullanılabilir.
- Pürüzsüz yüzeyi ve yuvarlatılmış uçları ile kablonun korunmasını ve çalışan kişinin güvenliğini garanti eder.
- Şebeke kablolarında en üst düzey desteği sağlar.
- Genel amaçlı uygulamalar için : 304 paslanmaz çelik

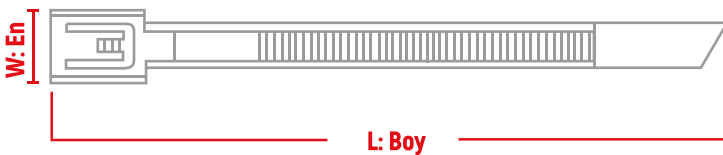

MALZEME: 304 Paslanmaz Çelik
SU EMİLİMİ: Yok
ALEV YÜRME: UL94V-2



ETİKETLİ KABLO BAĞLARI

Sipariş Kodu	Ürün Kodu	Boyutlar		Renk	Maksimum Sıkma Çapı (mm)	Açılma Mukavemeti (mm)	Ambalaj Adet		Birim Fiyat TL / Adet
		Uzunluk (mm)	En (mm)				Paket	Koli	
3501	JEKB-2510Y	100	2.5	Beyaz	20	8	100	30.000	0.550
3502	JEKB-4819D	190	4.8	Beyaz	48	22	100	12.000	1.300

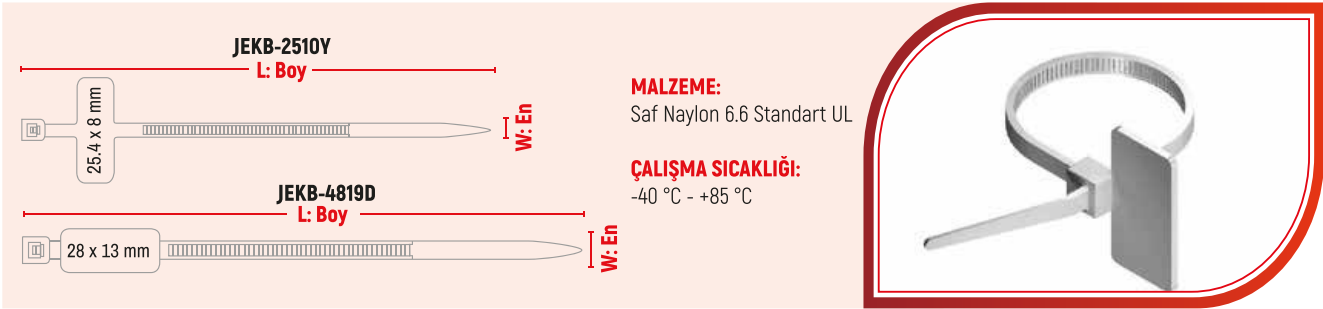

AÇILABİLİR KABLO BAĞLARI

Sipariş Kodu	Ürün Kodu	Boyutlar		Renk	Maksimum Sıkma Çapı (mm)	Açılma Mukavemeti (mm)	Ambalaj Adet		Birim Fiyat TL / Adet
		Uzunluk (mm)	En (mm)				Paket	Koli	
3503	JAKB-7620	200	7.6	Beyaz	50	36	100	5.000	1.800
3504	JAKB-7637	370	7.6	Beyaz	100	36	100	3.000	2.900

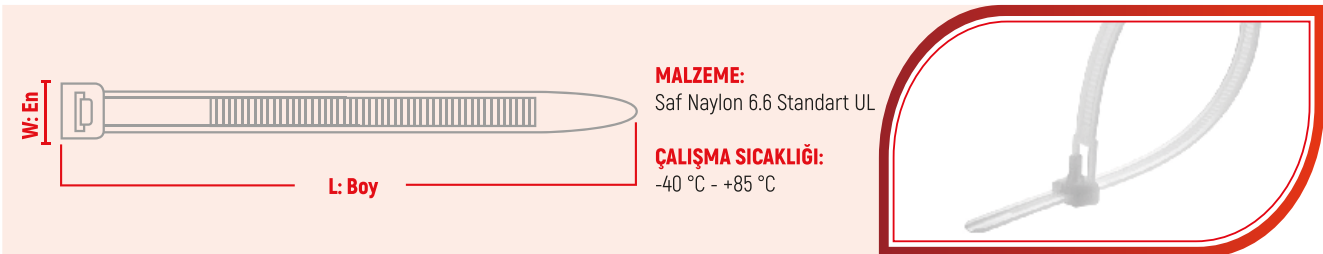

DİSTANSLI KABLO BAĞI

Sipariş Kodu	Ürün Kodu	Boyutlar		Renk	Maksimum Sıkma Çapı (mm)	Açılma Mukavemeti (mm)	Ambalaj Adet		Birim Fiyat TL / Adet
		Uzunluk (mm)	En (mm)				Paket	Koli	
3505	JDKB-2510	100	2.5	Beyaz	20	8	100	50.000	0.500
3506	JDKB-3615	150	3.6	Beyaz	35	18	100	30.000	0.750
3507	JDKB-4820	200	4.8	Beyaz	50	22	100	12.000	1.500

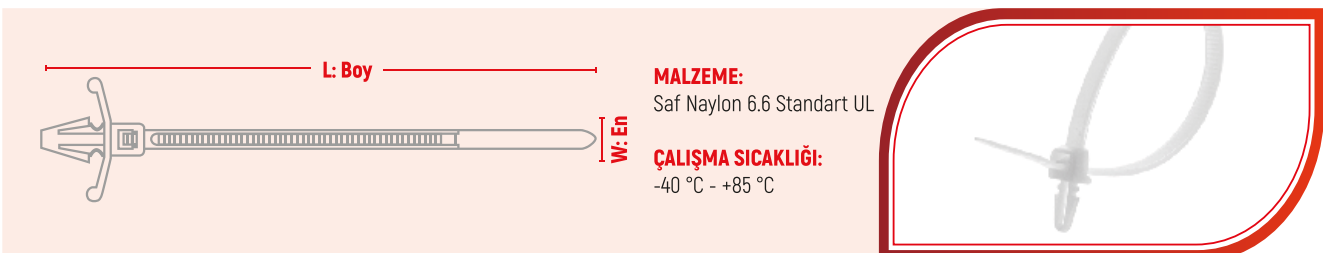

KARTUŞ YÜKSELTİCİ

Sipariş Kodu	Ürün Kodu	Boyutlar		Renk	Ambalaj Adet		Birim Fiyat TL / Adet
		A			Paket	Koli	
3521	JBS-9A	9.2		Beyaz	100	40.000	0.620
3522	JBS-13A	12.6		Beyaz	100	35.000	0.635
3523	JBS-16A	15.8		Beyaz	100	25.000	0.715

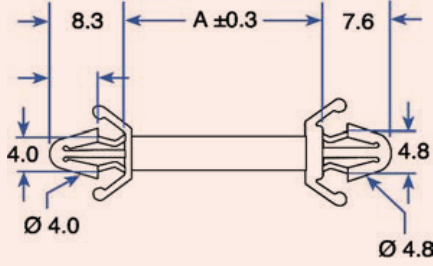

MALZEME:
Saf Naylon 6.6 Standart UL

ÇALIŞMA SICAKLIĞI:
-40 °C «» +85 °C



BETON KROŞE

Sipariş Kodu	Ürün Kodu	Boyutlar				Maksimum Sıkma Çapı (mm)	Renk	Ambalaj Adet		Birim Fiyat TL / Adet
		A	B	C	D			Paket	Koli	
3524	JH-2	9.5	36.0	6.0	9.5	ø 9.5	Siyah	100	5.000	0.987

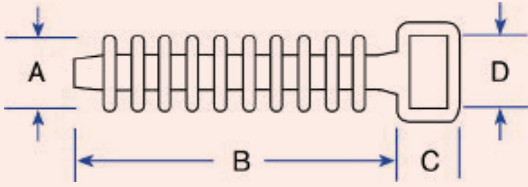

VİDALI KROŞE

Sipariş Kodu	Ürün Kodu	Boyutlar					Maksimum Sıkma Çapı (mm)	Renk	Ambalaj Adet		Birim Fiyat TL / Adet
		A	B	C	D	E			Paket	Koli	
3525	JK V - 1	14.9	9.5	6.9	4.5	7.8	4.8	Beyaz	100	5.000	0.500
3526	JK V - 2	22.2	15.9	9.7	6.4	12.6	7.6	Beyaz	100	5.000	0.710

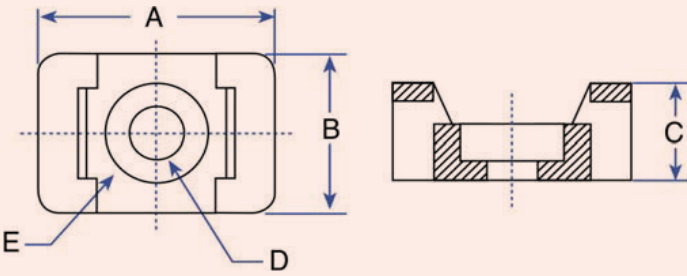

YAPIŞKANLI KROŞELER

Sipariş Kodu	Ürün Kodu	Boyutlar					Renk	Ambalaj Adet		Birim Fiyat TL / Adet
		A	B	C	D	H		Paket	Koli	
3513	JYK-1919B	19	19	3.6	∅ 3.2	4.0	Beyaz	100	20.000	0.68
3514	JYK-2828B	28	28	4.8	∅ 3.2	4.5	Beyaz	100	5.000	1.15
3515	JYK-1919S	19	19	3.6	∅ 3.2	4.0	Siyah	100	20.000	0.68
3516	JYK-2828S	28	28	4.8	∅ 3.2	4.5	Siyah	100	5.000	1.15



MALZEME:
Saf Naylon 6.6 Standart UL

ÇALIŞMA SICAKLIĞI:
-40 °C «» +85 °C



KAPAMA PARÇASI

Sipariş Kodu	Ürün Kodu	Boyutlar					Renk	Ambalaj Adet		Birim Fiyat TL / Adet
		A	B	C	D	H		Paket	Koli	
3517	JW-C4	19	19	3.6	∅ 3.2	4.0	Beyaz	100	20.000	0.35
3518	JW-C5	28	28	4.8	∅ 3.2	4.5	Beyaz	100	9.000	0.60

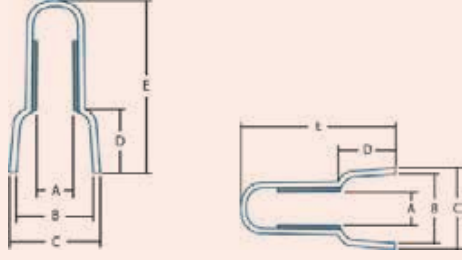

MALZEME:
Saf Naylon 6.6 Standart UL

ÇALIŞMA SICAKLIĞI:
105 °C «» +300 °C

MODELİ:
600 Volt Enerjiye Dayabilme



KABLO KELEPÇESİ

Sipariş Kodu	Ürün Kodu	Boyutlar						Renk	Ambalaj Adet		Birim Fiyat TL / Adet
		Q	Q1	A	B	C	D		Paket	Koli	
3519	JKK-14	7.4	6.6	10.3	9.1	1.27	M5	Beyaz	100	30.000	0.55
3520	JKK-38	10.9	9.7	11.9	9.2	1.27	M5	Beyaz	100	20.000	0.65

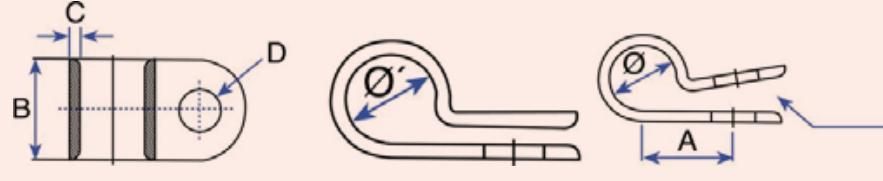



KABLO BAĞI ETİKET TAŞIYICI

Sipariş Kodu	Ürün Kodu	Boyutlar			Etiket Eni (mm)	Etiket Boyu (mm)	Renk	Ambalaj Adet		Birim Fiyat TL / Adet
		A	B	C				Paket	Koli	
3527	JET-1	35	10	8	32	7	Beyaz	100	12.500	1.30
3528	JET-2	45	20	8	42	17	Beyaz	100	6.000	2.20

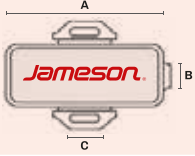

MALZEME:
Polipropilen

ÇALIŞMA SICAKLIĞI:
0°C «» +90 °C



YAPIŞKANLI PANO ETİKET TAŞIYICI

Sipariş Kodu	Ürün Kodu	Boyutlar		Etiket Eni (mm)	Etiket Boyu (mm)	Renk	Ambalaj Adet		Birim Fiyat TL / Adet
		A	B				Paket	Koli	
3529	JPET-1	30	17	27.5	14.4	Siyah	100	12.000	1.50
3530	JPET-2	50	17	49	15	Siyah	100	6.000	2.00
3531	JPET-3	75	17	72	15	Siyah	100	5.000	2.80



MALZEME:
ABS Altılık, PS Kapak + Çift Taraflı Bant

ÇALIŞMA SICAKLIĞI:
-40 °C «» +60 °C

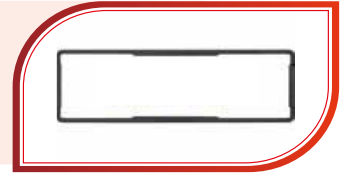

KABLO İŞARETLEME SİSTEMLERİ

BASKI HARFLERİ	BASKI NUMARASI	EC - 0		EC - 1		EC - 2	
		Sipariş Kodu	Fiyat	Sipariş Kodu	Fiyat	Sipariş Kodu	Fiyat
A	0	3601	59 TL.	3623	59 TL.	3645	59 TL.
B	1	3602		3624		3646	
C	2	3603		3625		3647	
D	3	3604		3626		3648	
E	4	3605		3627		3649	
F	5	3606		3628		3650	
G	6	3607		3629		3651	
H	7	3608		3630		3652	
I	8	3609		3631		3653	
K	9	3610		3632		3654	
L	9	3611	3633	3655			
M	9	3612	3634	3656			
N	9	3613	3635	3657			
O	9	3614	3636	3658			
P	9	3615	3637	3659			
R	9	3616	3638	3660			
S	9	3617	3639	3661			
T	9	3618	3640	3662			
U	9	3619	3641	3663			
V	9	3620	3642	3664			
Y	9	3621	3643	3665			
Z	9	3622	3644	3666			

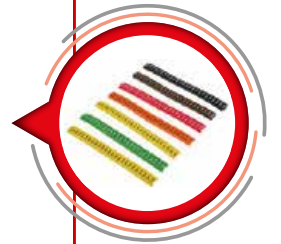

KABLO TOPLAMA SİRALLERİ

Sipariş Kodu	Ürün Kodu	O.D.	T	W	Kablo Kesit (mm ²)	Renk	Paket Miktarı (Mt)	Koli Miktarı (Mt)	Birim Fiyat TL / Adet
3701	JHS-6 (No1)	6	0.60	7.4	2.5 - 15	Beyaz	10	1.000	4.65
3702	JHS-8 (No2)	8	0.75	12	6 - 30	Beyaz	10	800	5.00
3703	JHS-10 (No3)	10	0.80	12.3	7.5 - 30	Beyaz	10	500	5.90
3704	JHS-12 (No4)	12	0.85	15	9 - 32	Beyaz	10	400	8.90
3705	JHS-15 (No5)	15	1.00	15.5	12 - 35	Beyaz	10	250	10.10

MALZEME: PE

Esnek yapısı sayesinde kabloların düzenlemesine yardımcı olur
Güçlü yapısı sayesinde tekrar kullanım için uygundur



Sipariş Kodu	Ürün Kodu	ÜRÜN AÇIKLAMASI	İÇ ÖLÇÜ	DIŞ ÖLÇÜ	Renk	RULO METRAJ	Birim Fiyat TL / Adet
7732	JKTS-1	20 LİK KABLO TOPLAMA SİRALİ	16MM	18MM	Gri	1.5MT	76.00
7734	JKTS-2	20 LİK KABLO TOPLAMA SİRALİ	16MM	18MM	Siyah	1.5MT	72.00
7735	JKTS-3	25 LİK KABLO TOPLAMA SİRALİ	22MM	25MM	Gri	1.5MT	90.00
7736	JKTS-4	25 LİK KABLO TOPLAMA SİRALİ	22MM	25MM	Siyah	1.5MT	84.00
7737	JKTS-5	30 LUK KABLO TOPLAMA SİRALİ	27MM	30MM	Gri	1.5MT	105.00
7738	JKTS-6	30 LUK KABLO TOPLAMA SİRALİ	27MM	30MM	Siyah	1.5MT	96.00
7739	JKTS-7	20 LİK KABLO TOPLAMA SİRALİ	16MM	18MM	Gri	25MT	24.00
7740	JKTS-8	20 LİK KABLO TOPLAMA SİRALİ	16MM	18MM	Siyah	25MT	21.75
7741	JKTS-9	25 LİK KABLO TOPLAMA SİRALİ	22MM	25MM	Gri	20MT	30.50
7742	JKTS-10	25 LİK KABLO TOPLAMA SİRALİ	22MM	25MM	Siyah	20MT	27.50
7742	JKTS-11	30 LUK KABLO TOPLAMA SİRALİ	27MM	30MM	Gri	15MT	37.00
7743	JKTS-12	30 LUK KABLO TOPLAMA SİRALİ	27MM	30MM	Siyah	15MT	34.00



**YENİ
ÜRÜN**



JAMESON®



KABLO YÜKSÜKLERİ VE KABLO UÇLARI



İZOLELİ KABLO YÜKSÜKLERİ FRANSIZ NORMU

Sipariş Kodu	Ürün Kodu	Renk	Kablo Kesit (mm ²)	Ebatlar (mm)					Kutuj Adet	Birim Fiyat TL / Adet	
				F	L	W	B	D			
3801	JYF-0.25		Menekşe	0.25 mm ²	8.0	12.0	1.9	4.4	1.1	1.000	0.285
3802	JYF-0.34		Pembe	0.34 mm ²	8.0	12.0	1.9	4.4	1.1	1.000	0.285
3803	JYF-0.50		Beyaz	0.50 mm ²	8.0	14.0	2.6	6.0	1.3	1.000	0.155
3804	JYF-0.75		Mavi	0.75 mm ²	8.0	14.0	2.8	6.3	1.5	1.000	0.155
3805	JYF-1.0		Kırmızı	1.00 mm ²	8.0	14.0	3.0	6.3	1.7	1.000	0.155
3806	JYF-1.5		Siyah	1.50 mm ²	8.0	14.0	3.5	6.3	2.0	1.000	0.175
3807	JYF-2.5		Gri	2.50 mm ²	8.0	14.0	4.2	7.4	2.5	500	0.220
3808	JYF-4.0		Turuncu	4.00 mm ²	10.0	17.0	4.8	7.4	3.2	500	0.370
3809	JYF-6.0		Yeşil	6.00 mm ²	12.0	20.0	6.3	8.5	3.9	250	0.490
3810	JYF-10.0		Kahve	10.0 mm ²	12.0	20.0	6.3	8.5	3.9	100	0.620
3811	JYF-16.0		Bej	16.0 mm ²	12.0	24.0	8.8	10.0	6.2	100	0.900
3812	JYF-25.0		Siyah	25.0 mm ²	16.0	28.0	11.2	12.0	7.7	50	1.500
3813	JYF-35.0		Kırmızı	35.0 mm ²	16.0	30.0	12.7	14.0	8.7	50	1.840
3814	JYF-50.0		Mavi	50.0 mm ²	20.0	36.0	15.0	16.0	10.9	25	3.550
3815	JYF-70.0		Sarı	70.0 mm ²	21.0	37.0	16.0	17.0	14.3	25	6.600
3830	JYF-95.0		Kırmızı	95.0 mm ²	20.0	36.0	15.0	16.0	10.9	25	11.250

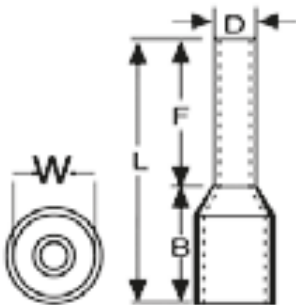

STANDART: DIN 46228

MALZEME: Bakır, Kalay Kaplı

İZOLASYON: Naylon

ÇALIŞMA SICAKLIĞI:
Maksimum 105 ° 600 volt Arası



İZOLELİ KABLO YÜKSÜKLERİ ALMAN NORMU

Sipariş Kodu	Ürün Kodu	Renk	Kablo Kesit (mm ²)	Ebatlar (mm)					Kutuj Adet	Birim Fiyat TL / Adet	
				F	L	W	B	D			
3816	JYA-0.25		Mavi	0.25 mm ²	8.0	12.0	1.6	2.8	0.9	1.000	0.285
3817	JYA-0.34		Turkuaz	0.34 mm ²	8.0	12.0	1.9	4.4	1.1	1.000	0.285
3818	JYA-0.50		Turuncu	0.50 mm ²	8.0	12.0	1.9	4.4	1.1	1.000	0.155
3819	JYA-0.75		Beyaz	0.75 mm ²	8.0	14.0	2.6	6.0	1.3	1.000	0.155
3820	JYA-1.0		Sarı	1.00 mm ²	8.0	14.0	2.8	6.3	1.5	1.000	0.155
3821	JYA-1.5		Kırmızı	1.50 mm ²	8.0	14.0	3.0	6.3	1.7	1.000	0.175
3822	JYA-2.5		Mavi	2.50 mm ²	8.0	14.0	3.5	6.3	2.0	500	0.220
3823	JYA-4.0		Gri	4.00 mm ²	8.0	14.0	4.2	7.4	2.5	500	0.370
3824	JYA-6.0		Siyah	6.00 mm ²	10.0	17.0	4.8	7.4	3.2	250	0.490
3825	JYA-10.0		Bej	10.0 mm ²	12.0	20.0	6.3	8.5	3.9	100	0.620
3826	JYA-16.0		Yeşil	16.0 mm ²	12.0	22.0	7.6	8.8	4.9	100	0.900
3827	JYA-25.0		Kahve	25.0 mm ²	12.0	24.0	8.8	10.0	6.2	50	1.500
3828	JYA-35.0		Bej	35.0 mm ²	16.0	28.0	11.2	12.0	7.7	50	1.840
3829	JYA-50.0		Yeşil	50.0 mm ²	16.0	30.0	12.7	14.0	8.7	25	3.550

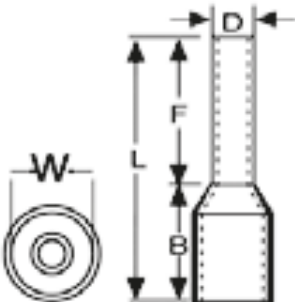

STANDART: DIN 46228

MALZEME: Bakır, Kalay Kaplı

İZOLASYON: Naylon

ÇALIŞMA SICAKLIĞI:
Maksimum 105 ° 600 volt Arası



ÇİFT GİRİŞLİ KABLO YÜKSÜKLERİ FRANSIZ NORMU

Sipariş Kodu	Ürün Kodu	Renk	Kablo Kesit (mm ²)	Ebatlar (mm)					Kutuj Adet	Birim Fiyat TL / Adet
				F	L	W	B	D		
3831	JCY-0.50F	 Beyaz	0.50 mm ²	8.0	14.0	5.0	6.5	1.8	1.000	0.275
3832	JCY-0.75F	 Mavi	0.75 mm ²	8.0	14.0	5.5	6.7	2.1	500	0.290
3833	JCY-1.0F	 Kırmızı	1.00 mm ²	8.0	14.0	5.5	7.1	2.4	500	0.300
3834	JCY-1.5F	 Siyah	1.50 mm ²	8.0	14.0	6.4	7.5	2.6	500	0.375
3835	JCY-2.5F	 Gri	2.50 mm ²	10.0	14.0	8.0	8.5	3.3	250	0.620
3836	JCY-4.0F	 Turuncu	4.00 mm ²	12.0	17.0	8.0	11.1	4.2	200	0.720
3837	JCY-6.0F	 Yeşil	6.00 mm ²	14.0	20.0	9.5	12.1	5.3	100	0.870
3838	JCY-10.0F	 Kahve	10.0 mm ²	14.0	27.0	12.6	12.6	6.9	50	1.350
3839	JCY-16.0F	 Bej	16.0 mm ²	14.0	31.0	19.0	17.3	8.7	50	1.600

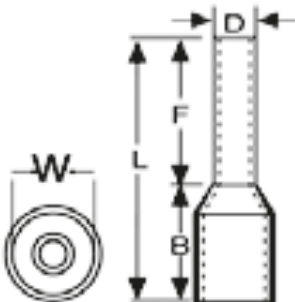
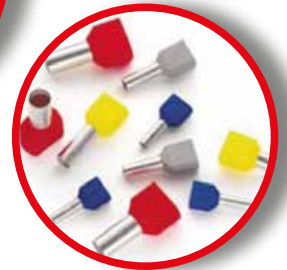
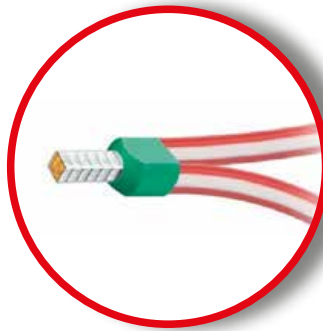
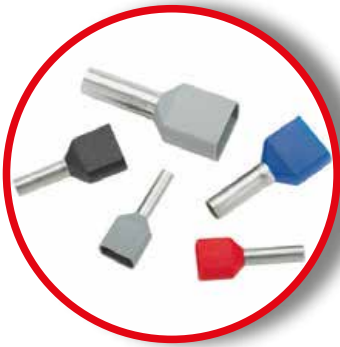

STANDART: DIN 46228

MALZEME: Bakır, Kalay Kaplı

İZOLASYON: Naylon

ÇALIŞMA SICAKLIĞI:
Maksimum 105 ° 600 volt Arası



ÇİFT GİRİŞLİ KABLO YÜKSÜKLERİ ALMAN NORMU

Sipariş Kodu	Ürün Kodu	Renk	Kablo Kesit (mm ²)	Ebatlar (mm)					Kutuj Adet	Birim Fiyat TL / Adet	
				F	L	W	B	D			
3840	JCY-0.50A		Turuncu	0.50 mm ²	8.0	14.0	5.0	6.5	1.8	1.000	0.275
3841	JCY-0.75A		Beyaz	0.75 mm ²	8.0	14.0	5.5	6.7	2.1	500	0.290
3842	JCY-1.0A		Sarı	1.00 mm ²	8.0	14.0	5.5	7.1	2.4	500	0.300
3843	JCY-1.5A		Kırmızı	1.50 mm ²	8.0	14.0	6.4	7.5	2.6	500	0.370
3844	JCY-2.5A		Mavi	2.50 mm ²	10.0	14.0	8.0	8.5	3.3	250	0.620
3845	JCY-4.0A		Gri	4.00 mm ²	12.0	17.0	8.0	11.1	4.2	200	0.720
3846	JCY-6.0A		Siyah	6.00 mm ²	14.0	20.0	9.5	12.1	5.3	100	0.870
3847	JCY-10.0A		Bej	10.0 mm ²	14.0	27.0	12.6	12.6	6.9	50	1.350
3848	JCY-16.0A		Yeşil	16.0 mm ²	14.0	31.0	19.0	17.3	8.7	50	1.600

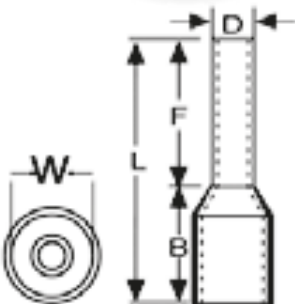

STANDART: DIN 46228

MALZEME: Bakır, Kalay Kaplı

İZOLASYON: Naylon

ÇALIŞMA SICAKLIĞI:
Maksimum 105 ° 600 volt Arası



İZOLESİZ KABLO YÜKSÜKLERİ

Sipariş Kodu	Ürün Kodu	Kablo Kesit (mm ²)	Ebatlar (mm)				Kutuj Adet	Birim Fiyat TL / Adet
			L	W	D	C		
3849	JKY-050	0.50 mm ²	10	2.1	1.3	1.0	2.000	0.155
3850	JKY-075	0.75 mm ²	10	2.3	1.5	1.2	1.000	0.155
3851	JKY-1.0	1.00 mm ²	10	2.5	1.7	1.4	1.000	0.155
3852	JKY-1.5	1.50 mm ²	10	2.8	2.0	1.7	1.000	0.170
3853	JKY-2.5	2.50 mm ²	12	3.4	2.5	2.2	1.000	0.235
3854	JKY-4.0	4.00 mm ²	12	4.0	3.2	2.8	1.000	0.300
3855	JKY-6.0	6.00 mm ²	12	4.7	3.9	3.5	500	0.430
3856	JKY-10.0	10.0 mm ²	15	5.8	4.9	4.5	250	0.730
3857	JKY-16.0	16.0 mm ²	15	7.5	6.2	5.8	250	0.900
3858	JKY-25.0	25.0 mm ²	16	9.1	7.9	7.5	100	1.350
3859	JKY-35.0	35.0 mm ²	16	10.2	8.7	8.3	100	1.500
3860	JKY-50.0	50.0 mm ²	22	12.7	10.9	10.3	50	3.200
3861	JKY-70.0	70.0 mm ²	25.2	13.5	5.36	4.68	50	3.840
3862	JKY-95.0	95.0 mm ²	25.2	14.0	5.38	5.35	25	4.750

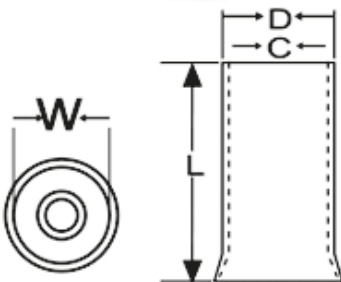

STANDART: DIN 46228

MALZEME: Bakır, Kalay Kaplı



YUVARLAK TİP İZOLELİ KABLO UÇLARI

Sipariş Kodu	Ürün Kodu	Renk	Kablo Kesit (mm ²)	Civata Ölçüsü	Ebatlar (mm)						Kutu Adet	Birim Fiyat TL / Adet
					d2	d3	l	d1	d4	a		
3901	JYU-301	Kırmızı	0.50 - 1.50 mm ²	M3	3.2	6.0	16.0	1.6	4.0	10.0	200	0.480
3902	JYU-401	Kırmızı		M4	4.3	8.0	17.0	1.6	4.0	10.0	200	0.700
3903	JYU-501	Kırmızı		M5	5.3	10.0	18.0	1.6	4.0	10.0	200	0.710
3904	JYU-601	Kırmızı		M6	6.5	10.0	18.0	1.6	4.0	10.0	200	1.150
3905	JYU-801	Kırmızı		M8	8.4	14.0	22.0	1.6	4.0	10.0	200	1.180

Sipariş Kodu	Ürün Kodu	Renk	Kablo Kesit (mm ²)	Civata Ölçüsü	Ebatlar (mm)						Kutu Adet	Birim Fiyat TL / Adet
					d2	d3	l	d1	d4	a		
3906	JYU-302	Mavi	1.50 - 2.50 mm ²	M3	3.2	6.0	16.0	2.3	4.5	10.0	200	0.900
3907	JYU-402	Mavi		M4	4.3	8.0	17.0	2.3	4.5	10.0	200	0.900
3908	JYU-502	Mavi		M5	5.3	10.0	19.0	2.3	4.5	10.0	200	0.920
3910	JYU-602	Mavi		M6	6.5	11.0	20.0	2.3	4.5	10.0	200	1.280
3911	JYU-802	Mavi		M8	8.4	14.0	22.0	2.3	4.5	10.0	200	1.280
3912	JYU-1002	Mavi		M10	10.5	15.0	22.0	2.3	4.5	10.0	200	1.300

Sipariş Kodu	Ürün Kodu	Renk	Kablo Kesit (mm ²)	Civata Ölçüsü	Ebatlar (mm)						Kutu Adet	Birim Fiyat TL / Adet
					d2	d3	l	d1	d4	a		
3913	JYU-406	Sarı	4.00 - 6.00 mm ²	M4	4.3	8.6	21.0	3.6	6.3	13.0	100	1.870
3914	JYU-506	Sarı		M5	5.3	10.0	22.0	3.6	6.3	13.0	100	1.870
3915	JYU-606	Sarı		M6	6.5	11.0	22.5	3.6	6.3	13.0	100	2.100
3916	JYU-806	Sarı		M8	8.4	14.0	26.0	3.6	6.3	13.0	100	2.650
3917	JYU-1006	Sarı		M10	10.5	18.0	28.0	3.6	6.3	13.0	100	2.700
3918	JYU-1206	Sarı		M12	13.0	18.0	28.0	3.6	6.3	13.0	100	2.720

3919	JYU-610	Kırmızı	8.00 - 10.00 mm ²	M6	6.7	23.5	30.0	4.5	8.0	17.0	50	3.600
3920	JYU-810	Kırmızı		M8	8.4	26.3	36.0	4.5	8.0	17.0	50	4.000

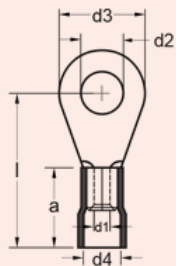

STANDART: DIN 46228

MALZEME: Bakır, Kalay Kaplı



ÇATAL TIP İZOLELİ KABLO UÇLARI

Sipariş Kodu	Ürün Kodu	Renk	Kablo Kesit (mm ²)	Civata Ölçüsü	Ebatlar (mm)						Kutu Adet	Birim Fiyat TL / Adet
					d2	d3	l	d1	d4	a		
3921	JÇU-3001	Kırmızı	0.50 - 1.50 mm ²	M3	3.2	6.0	16.0	1.6	4.0	10.0	200	0.620
3922	JÇU-4001	Kırmızı		M4	4.3	8.0	17.0	1.6	4.0	10.0	200	0.650
3923	JÇU-5001	Kırmızı		M5	5.3	10.0	18.0	1.6	4.0	10.0	200	0.670
3924	JÇU-6001	Kırmızı		M6	6.5	11.0	20.0	1.6	4.0	10.0	200	0.750

Sipariş Kodu	Ürün Kodu	Renk	Kablo Kesit (mm ²)	Civata Ölçüsü	Ebatlar (mm)						Kutu Adet	Birim Fiyat TL / Adet
					d2	d3	l	d1	d4	a		
3925	JÇU-3002	Mavi	0.50 - 1.50 mm ²	M3	3.2	5.5	18.0	2.3	4.5	10.0	200	0.700
3926	JÇU-4002	Mavi		M4	4.3	6.8	17.0	2.3	4.5	10.0	200	0.750
3927	JÇU-5002	Mavi		M5	5.3	10.0	19.0	2.3	4.5	10.0	200	0.755
3928	JÇU-6002	Mavi		M6	6.5	11.0	21.0	2.3	4.5	10.0	200	0.950

Sipariş Kodu	Ürün Kodu	Renk	Kablo Kesit (mm ²)	Civata Ölçüsü	Ebatlar (mm)						Kutu Adet	Birim Fiyat TL / Adet
					d2	d3	l	d1	d4	a		
3929	JÇU-4006	Sarı	4.00 - 6.00 mm ²	M4	4.3	8.0	21.0	3.6	13.0	10.0	100	1.600
3930	JÇU-5006	Sarı		M5	5.3	10.0	22.0	3.6	6.3	13.0	100	1.650
3931	JÇU-6006	Sarı		M6	6.5	11.0	23.0	3.6	6.3	13.0	100	2.200
3932	JÇU-8006	Sarı		M8	8.4	14.0	26.0	3.6	6.3	13.0	100	2.550

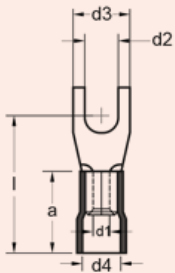

STANDART: DIN 46228

MALZEME: Bakır, Kalay Kaplı



EK MUFLARI İZOLELİ KABLO UÇLARI

Sipariş Kodu	Ürün Kodu	Renk	Kablo Kesit (mm ²)	Ebatlar (mm)			Kutu Adet	Birim Fiyat TL / Adet
				L	D	d1		
3933	JBY-251	Kırmızı	0.50 - 1.50 mm ²	24.6	4.0	1.7	200	0.950
3934	JBY-252	Mavi	1.50 - 2.50 mm ²	24.6	4.5	2.3	200	1.000
3935	JBY-256	Sarı	4.00 - 6.00 mm ²	26.5	6.3	3.4	100	1.700

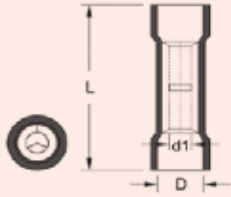

STANDART: DIN 46237
MALZEME: Bakır, Kalay Kaplı
İZOLASYON: PVC
ÇALIŞMA SICAKLIĞI: Maksimum 75° 300 Volt Arası



ERKEK TERMİNALLER İZOLELİ KABLO UÇLARI

Sipariş Kodu	Ürün Kodu	Renk	Kablo Kesit (mm ²)	Ebatlar (mm)					Kutu Adet	Birim Fiyat TL / Adet
				W	F	L	B	D		
3936	JBE-1041	Kırmızı	0.50 - 1.50 mm ²	4.0	8.5	21.5	10.5	3.8	200	1.700
3937	JBE-2052	Mavi	1.50 - 2.50 mm ²	5.0	8.5	21.2	10.5	4.7	200	1.900
3938	JBE-5056	Sarı	4.00 - 6.00 mm ²	5.0	8.5	24.0	13.0	6.2	200	2.500

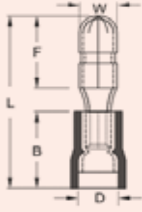

MALZEME: Pirinç, Kalay Kaplı, Bakır Yüksüklü
İZOLASYON: PVC
ÇALIŞMA SICAKLIĞI: Maksimum 75° 300 Volt Arası



DİŞİ TERMİNALLER İZOLELİ KABLO UÇLARI

Sipariş Kodu	Ürün Kodu	Renk	Kablo Kesit (mm ²)	Ebatlar (mm)					Kutu Adet	Birim Fiyat TL / Adet
				W	F	L	B	D		
3939	JBD-1041	Kırmızı	0.50 - 1.50 mm ²	3.9	7.0	23.3	10.5	3.8	200	2.000
3940	JBD-2052	Mavi	1.50 - 2.50 mm ²	4.9	7.0	23.3	10.5	4.7	100	2.250
3941	JBD-5056	Sarı	4.00 - 6.00 mm ²	4.9	7.0	25.1	12.5	6.2	100	2.800

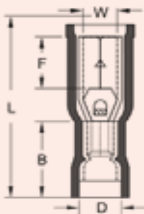

MALZEME: Pirinç, Kalay Kaplı, Bakır Yüksüklü
İZOLASYON: PVC
ÇALIŞMA SICAKLIĞI: Maksimum 75° 300 Volt Arası



DIŐI FASTON TİP İZOLELİ KABLO UÇLARI

SipariŐ Kodu	Ürün Kodu	Renk	Kablo Kesit (mm ²)	Soket GeniŐliĐi	Ebatlar (mm)					Kutu Adet	Birim Fiyat TL / Adet
					W	F	L	B	D		
3942	JFD-1288	Kırmızı	0.50 - 1.50 mm ²	0.8 x 2.80	3.2	6.5	19.0	10.5	3.8	200	0.530
3943	JFD-1488	Kırmızı		0.8 x 4.75	5.0	6.4	19.4	10.5	3.8	200	0.650
3944	JFD-1638	Kırmızı		0.8 x 6.35	6.6	7.5	20.8	10.5	3.8	200	0.850
3945	JFD-2288	Mavi	1.50 - 2.50 mm ²	0.8 x 2.80	3.2	6.5	19.0	10.5	3.8	200	0.650
3946	JFD-2488	Mavi		0.8 x 4.75	5.0	6.4	19.4	10.5	3.8	200	0.750
3947	JFD-2638	Mavi		0.8 x 6.35	6.6	7.5	20.8	10.5	3.8	200	0.850
3948	JFD-5638	Sarı	4.00 - 6.00 mm ²	0.8 x 6.35	6.6	7.5	23.3	13.0	6.2	200	1.050

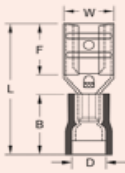

MALZEME: Piring, Kalay Kaplı
İZOLASYON: PVC
ÇALIŐMA SICAKLIĐI: Maksimum 75° 300 Volt Arası



TAM İZOLELİ DIŐI FASTON TİP KABLO UÇLARI

SipariŐ Kodu	Ürün Kodu	Renk	Kablo Kesit (mm ²)	Soket GeniŐliĐi	Ebatlar (mm)					Kutu Adet	Birim Fiyat TL / Adet
					W	F	L	B	D		
3949	JFFD-1288	Kırmızı	0.50 - 1.50 mm ²	0.8 x 2.80	3.2	6.5	19.0	10.5	3.8	200	0.750
3950	JFFD-1488	Kırmızı		0.8 x 4.75	5.0	6.4	20.8	10.5	3.8	200	0.850
3951	JFFD-1638	Kırmızı		0.8 x 6.35	6.6	7.5	21.8	10.5	3.8	200	1.200
3952	JFFD-2288	Mavi	1.50 - 2.50 mm ²	0.8 x 2.80	3.2	6.5	20.0	10.5	4.7	200	0.860
3953	JFFD-2488	Mavi		0.8 x 4.75	5.0	6.4	20.2	10.5	4.7	200	0.850
3954	JFFD-2638	Mavi		0.8 x 6.35	6.6	7.5	22.2	10.5	4.7	200	1.200
3955	JFFD-5638	Sarı	4.00 - 6.00 mm ²	0.8 x 6.35	6.6	7.5	24.2	12.5	6.2	100	1.320

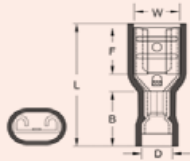

MALZEME: Piring, Kalay Kaplı
İZOLASYON: PVC
ÇALIŐMA SICAKLIĐI: Maksimum 75° 300 Volt Arası



TAM İZOLELİ POLYAMİD DIŐI FASTON TİP KABLO UÇLARI

SipariŐ Kodu	Ürün Kodu	Renk	Kablo Kesit (mm ²)	Soket GeniŐliĐi	Ebatlar (mm)					Kutu Adet	Birim Fiyat TL / Adet
					W	F	L	B	D		
3956	JPF-1638	Kırmızı	0.50 - 1.50 mm ²	0.8 x 6.35	6.6	7.5	21.5	11.0	4.0	200	2.550
3957	JPF-2638	Mavi	1.50 - 2.50 mm ²	0.8 x 6.35	6.6	7.5	21.5	11.0	5.0	200	2.550
3958	JPF-5638	Sarı	4.00 - 6.00 mm ²	0.8 x 6.35	6.6	7.5	24.2	13.0	6.5	100	3.050

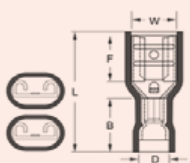

MALZEME: Piring, Kalay Kaplı
İZOLASYON: Polyamid
ÇALIŐMA SICAKLIĐI: Maksimum 75° 300 Volt Arası



İĞNE TİP İZOLELİ KABLO UÇLARI

Sipariş Kodu	Ürün Kodu	Renk	Kablo Kesit (mm ²)	Ebatlar (mm)					Kutu Adet	Birim Fiyat TL / Adet
				W	F	L	B	D		
3959	JIK-101	Kırmızı	0.50 - 1.50 mm ²	1.9	10.0	19.0	10.0	4.0	200	0.750
3960	JIK-102	Mavi	1.50 - 2.50 mm ²	1.9	12.0	21.8	10.0	4.5	200	0.900
3961	JIK-106	Sarı	4.00 - 6.00 mm ²	2.8	14.0	27.0	27.0	6.4	100	2.150

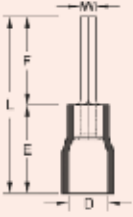

MALZEME: Bakır, Kalay Kaplı
İZOLASYON: PVC
ÇALIŞMA SICAKLIĞI: Maksimum 75° 300 Volt Arası

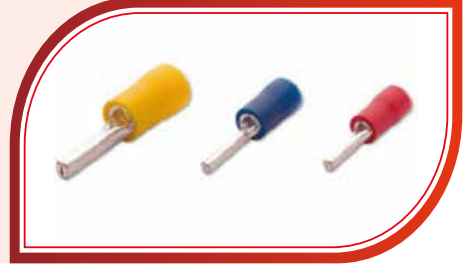

ERKEK / DIŞI GERİ DÖNÜŞLÜ TERMİNALLER

Sipariş Kodu	Ürün Kodu	Renk	Kablo Kesit (mm ²)	Soket Geniřliđi	Ebatlar (mm)					Kutu Adet	Birim Fiyat TL / Adet
					W	F	L	B	D		
3962	JFDEG-1861	Kırmızı	0.50 - 1.50 mm ²	0.8 x 2.80	6.6	8.0	22.5	10.5	3.8	100	1.550
3963	JFDEG-2862	Mavi	1.50 - 2.50 mm ²	0.8 x 4.75	6.6	8.0	22.5	10.5	4.7	100	1.550
3964	JFDEG-5866	Sarı	4.00 - 6.00 mm ²	0.8 x 6.35	6.6	8.0	24.0	13.0	6.2	100	1.700

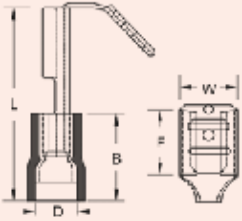

MALZEME: Pirinç, Kalay Kaplı
İZOLASYON: PVC
ÇALIŞMA SICAKLIĞI: Maksimum 75° 300 Volt Arası



TAM İZOLELİ POLYAMİD BAYRAK TİP TERMİNALLER

Sipariş Kodu	Ürün Kodu	Renk	Kablo Kesit (mm ²)	Ebatlar (mm)			Kutu Adet	Birim Fiyat TL / Adet
				W	F	L		
3965	JPFDEB-1861	Kırmızı	0.8 x 6.35	6.6	7.6	16.0	100	1.800
3966	JPFDEB-2862	Mavi	0.8 x 6.35	6.6	7.6	16.0	100	1.800

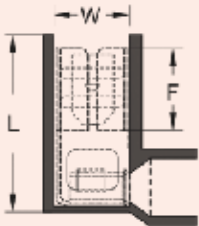

MALZEME: Pirinç, Kalay Kaplı
İZOLASYON: Polyamid
ÇALIŞMA SICAKLIĞI: Maksimum 75° 300 Volt Arası



ERKEK FASTON TİP KABLO UÇLARI

Sipariş Kodu	Ürün Kodu	Renk	Kablo Kesit (mm ²)	Soket Geniřlięi	Ebatlar (mm)					Kutu Adet	Birim Fiyat TL / Adet
					W	F	L	B	D		
3967	JFE-1288	Kırmızı	0.50 - 1.50 mm ²	0.8 x 2.80	2.8	6.5	19.2	10.5	3.8	200	0.590
3968	JFE-1488	Kırmızı		0.8 x 4.75	4.8	6.7	19.8	10.5	3.8	200	0.590
3969	JFE-1638	Kırmızı		0.8 x 6.35	6.35	6.35	21.8	10.5	3.8	200	0.700
3970	JFE-2288	Mavi	1.50 - 2.50 mm ²	0.8 x 2.80	2.8	6.7	19.8	10.5	4.7	200	0.590
3971	JFE-2488	Mavi		0.8 x 4.75	4.8	6.7	19.8	10.5	4.7	200	0.590
3972	JFE-2638	Mavi		0.8 x 6.35	6.35	7.7	21.8	10.5	4.7	200	0.750
3973	JFE-5638	Sarı	4.00 - 6.00 mm ²	0.8 x 6.35	6.35	7.7	24.8	13.0	6.2	200	0.940

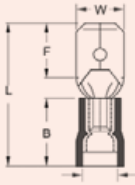

MALZEME: Piring, Kalay Kaplı
İZOLASYON: PVC
ÇALIŞMA SICAKLIĞI: Maksimum 75° 300 Volt Arası



VİDALI BUAT KLEMENSLERİ

Sipariş Kodu	Ürün Kodu	Renk	Ebatlar (mm)					Kutu Adet	Birim Fiyat TL / Adet
			A	B	C	D	E		
3974	J-1	Gri	3.8	6.70	8.60	5.80	15.20	1.000	0.430
3975	J-2	Mavi	4.10	7.00	9.80	5.90	17.60	1.000	0.500
3976	J-3	Turuncu	5.00	9.90	12.20	7.80	22.00	500	0.675
3977	J-4	Sarı	6.00	11.20	14.00	7.90	24.00	500	1.150
3978	J-6	Kırmızı	7.50	13.00	16.40	9.15	26.50	500	1.495

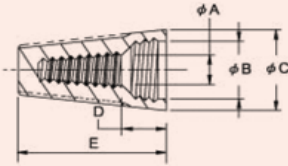

MALZEME: Piring, Kalay Kaplı
İZOLASYON: PVC
ÇALIŞMA SICAKLIĞI: Maksimum 75° 300 Volt Arası



HIZLI KABLO EKLEME PARÇASI

Sipariş Kodu	Ürün Kodu	Renk	Kablo Kesit (mm ²)	Ebatlar (mm)			Kutu Adet	Birim Fiyat TL / Adet
				W	F	L		
3979	JP-1	Kırmızı	0.50 - 1.00	4.0	10.6	20.0	500	1.000
3980	JP-2	Mavi	1.50 - 2.50	4.0	10.6	20.0	500	1.000
3981	JP-5	Sarı	4.00 - 6.00	4.0	2.0	20.0	250	1.650

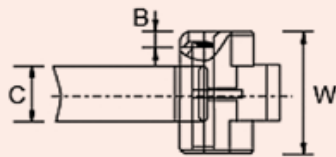

MALZEME: Piring, Kalay Kaplı
İZOLASYON: Naylon
ÇALIŞMA SICAKLIĞI: Maksimum 75° 300 Volt Arası



İZOLESİZ KABLO UCU VE KONNEKTÖRLERİ



SİPARİŞ KODU	4001	4002	4003	4004	4005
ÜRÜN KODU	JF1/2D	JF1D MİNİ	JF1D	JF3D	JF2D TRK
AÇIKLAMA	2.8 Mikro Dişi Terminal	4.8 Mini Dişi Terminal	6.3 Dişi Terminal	9.5 Dişi Terminal	6.3 Tırnaklı Dişi Terminal
KUTU ADET	1.000	500	300	100	300
BİRİM FİYATI TL./Ad.	0.300	0.450	0.600	1.400	0.600



SİPARİŞ KODU	4006	4007	4008	4009	4010
ÜRÜN KODU	JF1D EĞRİ	JF1D E	JKN 1-03	JKN 1-04	JKN 2.5-04
AÇIKLAMA	6.3 Eğri Dişi Terminal	6.3 Erkek Geri Dönüşümlü Terminal	M3 Topraklama Terminali	M4 Topraklama Terminali	M4 Topraklama Terminali
KUTU ADET	250	200	500	500	500
BİRİM FİYATI TL./Ad.	0.650	1.150	0.500	0.500	0.500



SİPARİŞ KODU	4011	4012	4013	4014	4015
ÜRÜN KODU	JKN 2.5-05	JKN 2.5-06	JKN 4-04	JKN 4-05	JKN 4-06
AÇIKLAMA	M5 Topraklama Terminali	M6 Topraklama Terminali	M4 Topraklama Terminali	M5 Topraklama Terminali	M6 Topraklama Terminali
KUTU ADET	500	500	250	250	250
BİRİM FİYATI TL./Ad.	0.500	0.500	1.150	1.150	1.150



SİPARİŞ KODU	4016	4017	4018	4019	4020
ÜRÜN KODU	JKN 6-06	JKN 8-08	JKN 10-10	JK 2.5	JK 4
AÇIKLAMA	M6 Topraklama Terminali	M8 Topraklama Terminali	M10 Topraklama Terminali	Boru Tip Topraklama Terminali	Boru Tip Topraklama Terminali
KUTU ADET	150	150	100	1.000	500
BİRİM FİYATI TL./Ad.	1.500	1.500	1.800	0.600	1.000



SİPARİŞ KODU	4021	4022	4023	4024	4025
ÜRÜN KODU	JK 6	JF1E ÇK	JF1EU1	R TİPİ KONNEKTÖR	JF1D KILIF
AÇIKLAMA	Boru Tip Topraklama Terminali	6.3 Erkek Terminal	6.3 Uzun Erkek Terminal	6.3 Kilitli Konnektör	6.3 Terminal Kılıfı
KUTU ADET	250	300	300	300	300
BİRİM FİYATI TL./Ad.	1.100	0.600	0.750	0.350	0.300

JAMESON®



BAĞLANTI ELEMENLARI



www.kivilcimelektrik.com.tr

SKP-E EKONOMİK TİP KABLO PABUCU

Sipariş Kodu	Ürün Kodu	Kablo Kesit (mm ²)	Delik Çapı Ø	Ebatlar (mm)						Kutu Adet	Birim Fiyat TL / Adet
				d	d1	d2	l	a	b		
4101	SKP-E 16-6	16 mm ²	M6	6.5	5.5	7.0	32.5	11.0	10.0	500	3.95
4102	SKP-E 16-8		M8	8.5	5.5	7.0	32.5	11.0	10.0	500	4.00
4103	SKP-E 25-6	25 mm ²	M6	6.5	7.0	9.0	38.5	16.0	13.0	400	8.05
4104	SKP-E 25-8		M8	8.5	7.0	9.0	38.5	16.0	13.0	400	8.05
4105	SKP-E 35-6	35 mm ²	M6	6.5	8.5	10.5	43.5	19.0	15.5	300	11.10
4106	SKP-E 35-8		M8	8.3	8.5	10.5	43.5	19.0	15.5	300	11.10
4107	SKP-E 50-8	50 mm ²	M8	8.5	10.0	12.0	51.5	21.0	17.6	200	13.92
4108	SKP-E 50-10		M10	10.5	10.0	12.0	51.5	21.0	17.6	200	13.92
4109	SKP-E 70-10	70 mm ²	M10	10.5	11.5	14.0	55.5	23.0	20.7	100	22.85
4110	SKP-E 70-12		M12	13.0	11.5	14.0	55.5	23.0	20.7	100	22.85
4111	SKP-E 95-10	95 mm ²	M10	10.5	13.5	16.0	58.5	26.0	23.5	75	26.85
4112	SKP-E 95-12		M12	13.0	13.5	16.0	58.5	26.0	23.5	75	26.85
4113	SKP-E 120-10	120 mm ²	M10	10.5	15.5	18.0	71.0	29.0	26.7	50	39.88
4114	SKP-E 120-12		M12	13.0	15.5	18.0	71.0	29.0	26.7	50	39.88
4115	SKP-E 150-10	150 mm ²	M10	10.5	16.5	20.0	76.0	30.0	29.2	40	54.20
4116	SKP-E 150-12		M12	13.0	16.5	20.0	76.5	30.0	29.2	40	54.20
4117	SKP-E 185-12	185 mm ²	M12	13.0	18.5	22.0	82.0	33.0	32.3	30	70.20
4118	SKP-E 185-16		M16	17.0	18.5	22.0	82.0	33.0	32.3	30	70.20
4119	SKP-E 240-12	240 mm ²	M12	13.0	21.5	25.5	91.0	38.0	37.6	25	103.80
4120	SKP-E 240-16		M16	17.0	21.5	25.5	91.0	38.0	37.6	25	103.80

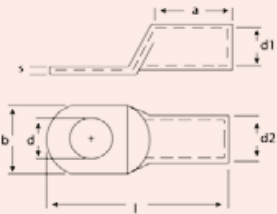

MALZEME: EN13600 Standart Bakır
Yüzey: Kalay



SKP-S STANDART TİP KABLO PABUCU

Sipariş Kodu	Ürün Kodu	Kablo Kesit (mm ²)	Delik Çapı Ø	Ebatlar (mm)								Kutu Adet	Birim Fiyat TL / Adet	
				d	d1	d2	l	l1	a	b	c1			c2
4121	SKP-S 10-5	10 mm ²	M5	5.5	4.4	6.0	27.5	21.6	10.0	10.3	6.0	6.0	1000	4.15
4122	SKP-S 10-6		M6	6.5	4.4	6.0	27.5	21.6	10.0	10.3	6.0	6.0	1000	4.15
4123	SKP-S 10-8		M8	8.5	4.4	6.0	27.5	21.6	10.0	13.5	6.0	6.0	1000	4.15
4124	SKP-S 16-6	16 mm ²	M6	6.5	5.5	8.0	32.6	25.0	12.0	11.2	7.0	8.0	500	6.00
4125	SKP-S 16-8		M8	8.5	5.5	8.0	32.6	25.0	12.0	13.7	7.0	8.0	500	6.30
4126	SKP-S 16-10		M10	10.5	5.5	8.0	32.6	25.0	12.0	16.0	7.0	8.0	500	6.30
4127	SKP-S 25-6	25 mm ²	M6	6.5	6.8	9.0	39.0	32.2	16.0	13.5	6.8	9.2	400	11.80
4128	SKP-S 25-8		M8	8.5	6.8	9.0	39.0	32.2	16.0	13.5	6.8	9.2	400	11.80
4129	SKP-S 25-10		M10	10.5	7.0	9.5	42.0	34.0	16.0	16.0	6.8	11.0	400	11.80
4130	SKP-S 35-6	35 mm ²	M6	6.5	8.2	11.0	44.0	35.7	19.0	15.7	8.0	9.7	200	15.70
4131	SKP-S 35-8		M8	8.5	8.2	11.0	44.0	35.7	19.0	15.7	8.0	9.7	200	15.70
4132	SKP-S 35-10		M10	10.5	8.2	11.0	48.0	38.0	19.0	15.7	10.0	12.0	200	15.70
4133	SKP-S 50-8	50 mm ²	M8	8.5	9.5	12.0	47.5	39.2	21.0	17.7	8.3	9.7	150	21.60
4134	SKP-S 50-10		M10	10.5	9.5	12.0	51.5	41.5	21.0	17.7	10.0	12.0	150	23.50
4135	SKP-S 50-12		M12	13.0	10.1	13.0	51.5	41.5	21.0	19.0	10.0	12.0	150	23.50
4136	SKP-S 50-14		M14	15.0	10.1	13.0	56.5	44.5	21.0	20.5	12.0	15.0	150	24.00
4137	SKP-S 70-8	70 mm ²	M8	8.5	11.2	14.5	54.6	44.6	23.0	21.1	10.0	12.0	100	33.30
4138	SKP-S 70-10		M10	10.5	11.2	14.5	54.6	44.6	23.0	21.1	10.0	12.0	100	33.30
4139	SKP-S 70-12		M12	13.0	11.2	14.5	54.6	44.6	23.0	21.1	10.0	12.0	100	33.30
4140	SKP-S 70-14		M14	15.0	11.2	14.5	62.6	47.6	23.0	21.4	15.0	15.0	100	38.00
4141	SKP-S 95-8	95 mm ²	M8	8.5	13.4	17.0	58.8	48.8	26.0	24.5	10.0	12.0	75	39.20
4142	SKP-S 95-10		M10	10.5	13.4	17.0	58.8	48.8	26.0	24.5	10.0	12.0	75	39.20
4143	SKP-S 95-12		M12	13.0	13.4	17.0	58.8	48.8	26.0	24.5	10.0	12.0	75	39.20
4144	SKP-S 120-10	120 mm ²	M10	10.0	15.5	19.0	69.0	56.6	29.0	28.0	13.0	14.5	50	53.00
4145	SKP-S 120-12		M12	13.0	15.5	19.0	69.0	56.6	29.0	28.0	13.0	14.5	50	53.00
4146	SKP-S 120-16		M16	17.0	15.5	19.0	69.0	56.6	29.0	28.0	13.0	14.5	50	54.00
4147	SKP-S 150-10	150 mm ²	M10	10.5	16.5	21.0	76.5	60.0	30.0	30.0	16.5	16.5	40	85.90
4148	SKP-S 150-12		M12	13.0	16.5	21.0	76.5	60.0	30.0	30.0	16.5	16.5	40	85.90
4149	SKP-S 150-16		M16	17.0	16.5	21.0	76.5	60.0	30.0	30.0	16.5	16.5	40	85.90
4150	SKP-S 185-12	185 mm ²	M12	13.0	5.5	23.0	82.5	65.5	33.0	34.0	17.0	18.0	30	102.00
4151	SKP-S 185-16		M16	17.0	5.5	23.0	82.5	65.5	33.0	34.0	17.0	18.0	30	102.00
4152	SKP-S 240-12	240 mm ²	M12	13.0	5.5	26.0	89.0	72.0	38.0	38.0	17.0	18.0	25	139.50
4153	SKP-S 240-16		M16	17.0	5.5	26.0	89.0	72.0	38.0	38.0	17.0	18.0	25	139.50

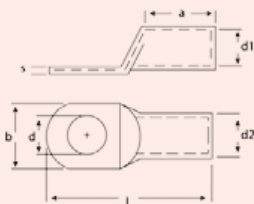

MALZEME: EN13600 Standart Bakır
Yüzey: Kalay



BİMETALİK SIKMALI KABLO PAPUÇLARI

Sipariş Kodu	Ürün Kodu	Kablo Kesit (mm ²)	Delik Çapı ∅	Ebatlar (mm)		Kutu Adet	Birim Fiyat USD / Adet
				d	l		
7360	JBM 16	16	M12	13.0	84.0	100	3.80
7361	JBM 25	25	M12	13.0	84.0	100	3.80
7362	JBM 35	35	M12	13.0	84.0	100	3.80
7363	JBM 50	50	M12	13.0	84.0	50	4.82
7364	JBM 70	70	M12	13.0	84.0	50	4.82
7365	JBM 95	95	M12	13.0	84.0	50	4.82
7366	JBM 120	120	M12	13.0	107.0	20	7.95
7367	JBM 150	150	M12	13.0	107.0	20	7.95
7368	JBM 185	185	M12	13.0	117.0	12	13.25
7369	JBM 240	240	M12	13.0	117.0	12	13.25
7370	JBM 300	300	M16	17.0	135.0	12	17.83
7371	JBM 400	400	M16	17.0	135.0	5	32.50



**YENİ
ÜRÜN**

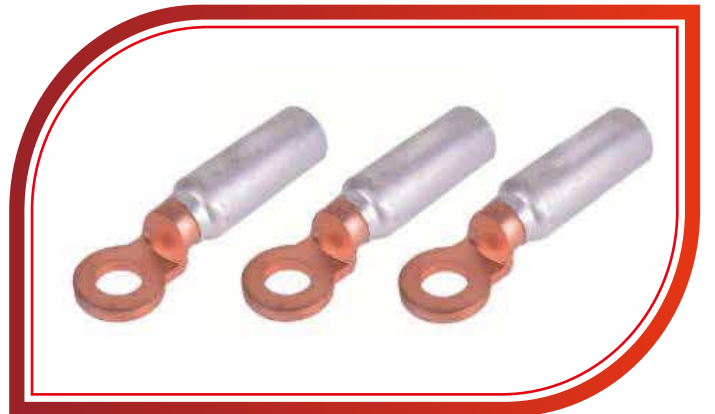

EK MUFLARI

Sipariş Kodu	Ürün Kodu	Kablo Kesit (mm ²)	Ebatlar (mm)			Kutu Adet	Birim Fiyat TL / Adet
			d1	d2	l		
4154	EKMUF - 10	10	4.4	6.0	27.0	1000	4.60
4155	EKMUF - 16	16	5.5	8.0	32.0	400	4.60
4156	EKMUF - 25	25	7.0	9.0	40.5	250	8.80
4157	EKMUF - 35	35	8.2	11.0	45.5	150	13.00
4158	EKMUF - 50	50	9.5	13.5	53.5	90	15.00
4159	EKMUF - 70	70	11.2	14.5	57.5	65	24.35
4160	EKMUF - 95	95	13.4	17.0	61.5	50	29.60
4161	EKMUF - 120	120	15.0	19.5	74.0	40	42.00
4162	EKMUF - 150	150	16.5	21.0	79.0	25	62.20
4163	EKMUF - 185	185	19.0	24.0	85.0	22	78.10
4164	EKMUF - 240	240	21.0	26.0	94.0	18	120.50

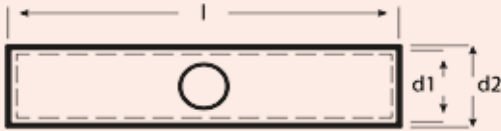

YERLİ ÜRETİM

MALZEME: EN13600 Standart Bakır
YÜZEY: Kalay



U KLEMENS

Sipariş Kodu	Ürün Kodu	Açıklama	Kutu Adet	Birim Fiyat TL / Adet
4165	JUK 6	6mm U Klemens	150	12.97
4166	JUK 10	10mm U Klemens	125	18.10
4167	JUK 16	16mm U Klemens	100	26.25
4168	JUK 25	25mm U Klemens	100	31.55
4169	JUK 35	35mm U Klemens	75	38.25
4170	JUK 50	50mm U Klemens	50	54.25
4171	JUK 70	70mm U Klemens	40	71.00
4172	JUK 95	95mm U Klemens	25	88.90
4173	JUK 120	120mm U Klemens	20	111.20
4174	JUK 150	150mm U Klemens	15	149.90



MONOFAZE MÜŞTEREK W OTOMAT BARALARI

Sipariş Kodu	Ürün Kodu	Bakır Kalınlığı	Boy	Modül	Amper	Açıklama	Kutu Adet	Birim Fiyat TL / Adet
4201	M - 531	1 mm	53 cm	30 Otomat için	80 A	Monofaze Müşterek W Otomat Bara	50	☎
4202	M - 1061	1 mm	106 cm	60 Otomat için	80 A	Monofaze Müşterek W Otomat Bara	50	☎
4203	M - 5315	1.5 mm	53 cm	30 Otomat için	100 A	Monofaze Müşterek W Otomat Bara	50	☎
4204	M - 10615	1.5 mm	106 cm	60 Otomat için	100 A	Monofaze Müşterek W Otomat Bara	50	☎

TRİFAZE MÜŞTEREK W OTOMAT BARALARI

Sipariş Kodu	Ürün Kodu	Bakır Kalınlığı	Boy	Modül	Amper	Açıklama	Kutu Adet	Birim Fiyat TL / Adet
4205	T - 221	1 mm	22 cm	4 Grup için	80 A	Trifaze Müşterek W Otomat Bara		☎
4206	T - 331	1 mm	33 cm	6 Grup için	80 A	Trifaze Müşterek W Otomat Bara		☎
4207	T - 441	1 mm	44 cm	8 Grup için	80 A	Trifaze Müşterek W Otomat Bara		☎
4208	T - 531	1 mm	53 cm	10 Grup için	80 A	Trifaze Müşterek W Otomat Bara	25	☎
4209	T - 1061	1 mm	106 cm	20 Grup için	80 A	Trifaze Müşterek W Otomat Bara	25	☎
4210	T - 2215	1.5 mm	22 cm	4 Grup için	100 A	Trifaze Müşterek W Otomat Bara		☎
4211	T - 3315	1.5 mm	33 cm	6 Grup için	100 A	Trifaze Müşterek W Otomat Bara		☎
4212	T - 4415	1.5 mm	44 cm	8 Grup için	100 A	Trifaze Müşterek W Otomat Bara		☎
4213	T - 5315	1.5 mm	53 cm	10 Grup için	100 A	Trifaze Müşterek W Otomat Bara	25	☎
4214	T - 10615	1.5 mm	106 cm	20 Grup için	100 A	Trifaze Müşterek W Otomat Bara	25	☎
4215	Jameson - Kapak					Bara Kapağı	500	☎

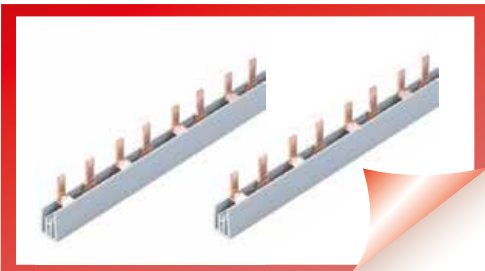

İSTEDİĞİNİZ ÖLÇÜDE KESİM YAPILIR.



MONTAJ RAYLARI

Sipariş Kodu	Ürün Kodu	Açıklama	Uzunluk (m)	Kutu Adet	Birim Fiyat TL / Adet
4175	JW-MR1	1mm Delikli Saç Montaj Rayı	1 m	50	☎
4176	JW-MR2	1mm Delikli Saç Montaj Rayı	2 m	25	☎
4182	JW-MR3	Ray Taşıyıcı Saç		100	☎

NÖTR TOPRAKLAMA BARALAR



Sipariş Kodu	Ürün Kodu	Bakır Kalınlığı	Uzunluk (m)	Kullanım Yeri	Kutu Adet	Birim Fiyat TL / Adet
4177	JNTB-1.5-31	15mm x 1,5mm	1 mt	31 Vida	50	☎
4178	JNTB-1.5-61	15mm x 1,5mm	1 mt	61 Vida	50	☎
4179	JNTB-2-31	15mm x 2mm	1 mt	31 Vida	50	☎
4180	JNTB-2-61	15mm x 2mm	1 mt	61 Vida	50	☎
4181	Nötr Bara Mesneti	15mm x 2mm	1 mt	31 Vida	10	☎



RAYA MONTAJLI PRİZ

Sipariş Kodu	Ürün Kodu	Açıklama	Kutu Adet	Birim Fiyat TL / Adet
4183	JPP	Raya Montaj (Kapaklı) Pano Prizi (16A/250V)	10	95.00



ERİYEN BANTLAR

SİPARİŞ KODU	ÜRÜN KODU	ÖLÇÜLER	KOLİ ADET	Birim Fiyat USD / Ad.
5701	JB-1401	19 mm x 0.8 mm x 8 m	60	3.25
5702	JB-1402	50 mm x 0.8 mm x 8 m	24	9.25



PVC İZOLE BANT

SİPARİŞ KODU	ÜRÜN KODU	ÖLÇÜLER	KOLİ ADET	Birim Fiyat USD / Ad.
5703	İZOLE BANT	0.50 mm x 50 mm x 9.1 m	36	☎



JKS SERİSİ KAPI SIVIÇLERİ

SİPARİŞ KODU	ÜRÜN KODU	KONTAK	AÇIKLAMA	KUTU ADET	KOLİ ADET	Birim Fiyat TL / Ad.
5808	JKS-10	NO	Açık Kontak Kapı Sivici	50	500	34.00
5809	JKS-01	NC	Kapalı Kontak Kapı Sivici	50	500	35.00
5810	JKS-12	1NO+1NC	(1NA+1NK)	50	500	40.00



2 KUTUPLU DAĞITICI ÜNİTELER



BİRİM FİYAT TL / AD	110.00	
SİPARİŞ KODU	4301	
ÜRÜN KODU	JD-2x7	
AKIM	125 Amper	
KABLO CİNSİ	Tek Damar	Çok Tellî
	Giriş	Çıkış
KABLO KESİTİ (mm ²)	1 x 10 - 35 mm ²	1 x 10 - 25 mm ² 5 x 1,5 - 6 mm ²
	1 x 10 - 16 mm ²	1 x 6 - 16 mm ² 5 x 1,5 - 6 mm ²
Ambalaj Adet	Paket	Koli
	1	138

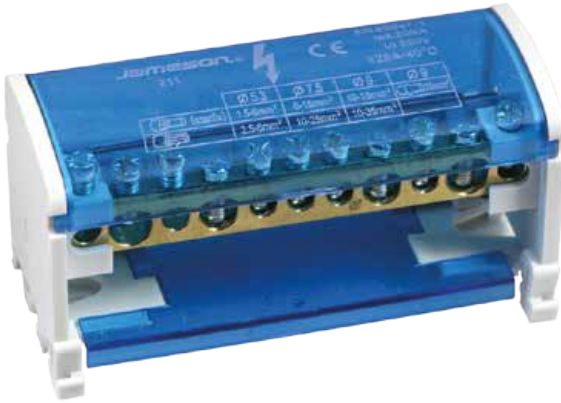

BİRİM FİYAT TL / AD	150.00	
SİPARİŞ KODU	4302	
ÜRÜN KODU	JD-2x11	
AKIM	125 Amper	
KABLO CİNSİ	Tek Damar	Çok Tellî
	Giriş	Çıkış
KABLO KESİTİ (mm ²)	2 x 10 - 35 mm ²	2 x 10 - 25 mm ² 7 x 2,5 - 6 mm ²
	2 x 10 - 16 mm ²	2 x 6 - 16 mm ² 7 x 1,5 - 6 mm ²
Ambalaj Adet	Paket	Koli
	1	84

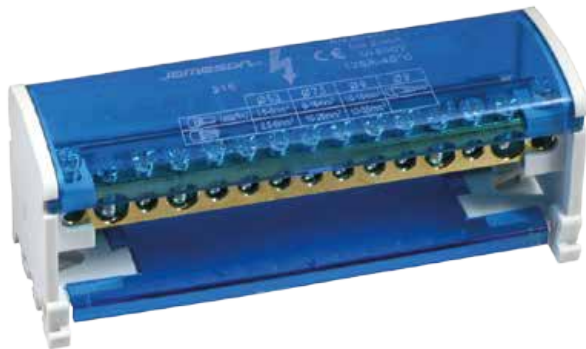

BİRİM FİYAT TL / AD	200.00	
SİPARİŞ KODU	4303	
ÜRÜN KODU	JD-2x15	
AKIM	125 Amper	
KABLO CİNSİ	Tek Damar	Çok Tellî
	Giriş	Çıkış
KABLO KESİTİ (mm ²)	2 x 10 - 35 mm ²	2 x 10 - 25 mm ² 11 x 2,5 - 6 mm ²
	2 x 10 - 16 mm ²	2 x 6 - 16 mm ² 11 x 1,5 - 6 mm ²
Ambalaj Adet	Paket	Koli
	1	72



4 KUTUPLU DAĞITICI ÜNİTELER



BİRİM FİYAT TL / AD	200.00	
SİPARİŞ KODU	4304	
ÜRÜN KODU	JD-4x7	
AKIM	125 Amper	
KABLO CİNSİ	Tek Damar	Çok Telli
	Giriş	Çıkış
KABLO KESİTİ (mm ²)	1 x 10 - 35 mm ²	1 x 10 - 25 mm ² 5 x 1,5 - 6 mm ²
	1 x 10 - 16 mm ²	1 x 6 - 16 mm ² 5 x 1,5 - 6 mm ²
Ambalaj Adet	Paket	Koli
	1	74

BİRİM FİYAT TL / AD	295.00	
SİPARİŞ KODU	4305	
ÜRÜN KODU	JD-4x11	
AKIM	125 Amper	
KABLO CİNSİ	Tek Damar	Çok Telli
	Giriş	Çıkış
KABLO KESİTİ (mm ²)	2 x 10 - 35 mm ²	2 x 10 - 25 mm ² 7 x 2,5 - 6 mm ²
	2 x 10 - 16 mm ²	2 x 6 - 16 mm ² 7 x 1,5 - 6 mm ²
Ambalaj Adet	Paket	Koli
	1	50

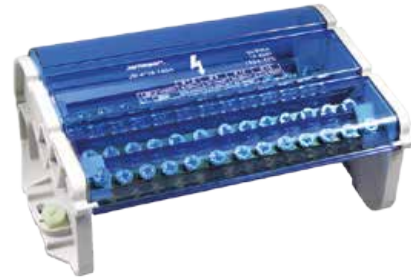
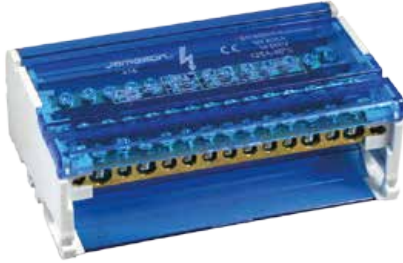

BİRİM FİYAT TL / AD	370.00	
SİPARİŞ KODU	4306	
ÜRÜN KODU	JD-4x15	
AKIM	125 Amper	
KABLO CİNSİ	Tek Damar	Çok Telli
	Giriş	Çıkış
KABLO KESİTİ (mm ²)	2 x 10 - 35 mm ²	2 x 10 - 25 mm ² 11 x 1,5 - 6 mm ²
	2 x 10 - 16 mm ²	2 x 6 - 16 mm ² 11 x 1,5 - 6 mm ²
Ambalaj Adet	Paket	Koli
	1	40

BİRİM FİYAT TL / AD	885.00	
SİPARİŞ KODU	4307	
ÜRÜN KODU	JD-4x12/160A	
AKIM	160 Amper	
KABLO CİNSİ	Tek Damar	Çok Telli
	Giriş	Çıkış
KABLO KESİTİ (mm ²)	1 x 10 - 50 mm ²	3 x 10 - 25 mm ² 8 x 1,5 - 6 mm ²
	1 x 10 - 50 mm ²	3 x 6 - 16 mm ² 8 x 1,5 - 6 mm ²
Ambalaj Adet	Paket	Koli
	1	18

TEK KUTUPLU DAĞITICI ÜNİTELER



BİRİM FİYAT TL / AD	90.00	
SİPARİŞ KODU	4308	
ÜRÜN KODU	JD-80A	
AKIM	80 Amper	
KABLO CİNSİ	Tek Damar	Çok Telli
KABLO KESİTİ (mm ²)	Giriş	Çıkış
	1 x 10 - 16 mm ²	4 x 2,5 - 6 mm ² 2 x 2,5 - 16 mm ²
Ambalaj Adet	Paket	Koli
	5	100



BİRİM FİYAT TL / AD	190.00	
SİPARİŞ KODU	4309	
ÜRÜN KODU	JD-125A	
AKIM	125 Amper	
KABLO CİNSİ	Tek Damar	Çok Telli
KABLO KESİTİ (mm ²)	Giriş	Çıkış
	1 x 10 - 35 mm ²	6 x 2,5 - 16 mm ² Köprü 1 x 6 - 16 mm ²
Ambalaj Adet	Paket	Koli
	5	75



BİRİM FİYAT TL / AD	195.00	
SİPARİŞ KODU	4310	
ÜRÜN KODU	JD-160A	
AKIM	160 Amper	
KABLO CİNSİ	Tek Damar	Çok Telli
KABLO KESİTİ (mm ²)	Giriş	Çıkış
	1 x 10 - 70 mm ²	6 x 2,5 - 16 mm ² Köprü 2 x 2,5 - 16 mm ²
Ambalaj Adet	Paket	Koli
	5	50

TEK KUTUPLU DAĞITICI ÜNİTELER



BİRİM FİYAT TL / AD	550.00	
SİPARİŞ KODU	4311	
ÜRÜN KODU	JD-250A	
AKIM	250 Amper	
KABLO CİNSİ	Tek Damar	Çok Telli
	Giriş	Çıkış
KABLO KESİTİ (mm ²)	1 x 35 - 120 mm ²	4 x 2,5 - 10 mm ² 5 x 2,5 - 16 mm ² 2 x 6 - 35 mm ²
	Ambalaj Adet	Paket 3



BİRİM FİYAT TL / AD	580.00	
SİPARİŞ KODU	4312	
ÜRÜN KODU	JD-400A	
AKIM	400 Amper	
KABLO CİNSİ	Tek Damar	Çok Telli
	Giriş	Çıkış
KABLO KESİTİ (mm ²)	1 x 95 - 185 mm ²	4 x 2,5 - 10 mm ² 5 x 2,5 - 16 mm ² 2 x 6 - 35 mm ²
	Ambalaj Adet	Paket 3



BİRİM FİYAT TL / AD	620.00	
SİPARİŞ KODU	4313	
ÜRÜN KODU	JD-500A	
AKIM	500 Amper	
KABLO CİNSİ	Tek Damar	Çok Telli
	Giriş	Çıkış
KABLO KESİTİ (mm ²)	8 x 24 mm ²	4 x 2,5 - 10 mm ² 5 x 2,5 - 16 mm ² 2 x 6 - 35 mm ²
	Ambalaj Adet	Paket 3







JAMESON®



ÇOK AMAÇLI KLEMENSLER



GEÇMELİ BUAT KLEMENS

Sipariş Kodu	Ürün Kodu	Renk	Kablo Kesiti	Ebatlar (mm)			Ambalaj Adet		Birim Fiyat TL / Adet	
				En	Boy	Yükseklik	Paket	Koli		
4401	JW 2.5-2	Beyaz	0.50 - 2.5 mm ²	9.8	16.4	5.8	200	10.000	2.10	
4402	JW 2.5-3	Turuncu	0.50 - 2.5 mm ²	13.9	16.4	5.8	200	10.000	2.40	
4403	JW 2,5 4	Kırmızı	0.50 - 2.5 mm ²	17.9	16.4	5.8	100	5000	3.00	
4404	JW 2,5-5	Sarı	0.50 - 2.5 mm ²	21.9	16.4	5.8	100	5000	3.20	
4405	JW 2,5-6	Kırmızı	0.50 - 2.5 mm ²	13.8	16.4	11.25	100	5000	4.00	
4406	JW 2,5-8	Gri	0.50 - 2.5 mm ²	17.8	16.4	11.25	100	5000	5.00	









ÇOK AMAÇLI KLEMENS

Sipariş Kodu	Ürün Kodu	Kablo Kesiti	Açıklama	Ambalaj Adet		Birim Fiyat TL / Adet	
				Paket	Koli		
4407	JW-412	0.14 - 4.0 mm ²	2 İletken Bağlantılı	100	5000	4.40	
4408	JW-413	0.14 - 4.0 mm ²	3 İletken Bağlantılı	100	5000	5.40	
4409	JW-414	0.14 - 4.0 mm ²	4 İletken Bağlantılı	50	2500	7.10	
4410	JW-415	0.14 - 4.0 mm ²	5 İletken Bağlantılı	50	2500	8.50	

ÇALIŞMA SICAKLIĞI: -40 °C «» 100 °C **NOMİNAL AKIM:** 32A **NOMİNAL GERİLİM:** 450V



DAĞITICILI BUAT KLEMENS

Sipariş Kodu	Ürün Kodu	Renk	Kablo Kesiti	Ebatlar (mm)			Ambalaj Adet		Birim Fiyat TL / Adet	
				En	Boy	Yükseklik	Paket	Koli		
7745	JCT 2-2	Beyaz	0.50 - 2.5 mm ²	13.6	40.3	14.5	50	2000	8.80	
7746	JCT 3-3	Beyaz	0.50 - 2.5 mm ²	18.6	40.3	14.5	50	2000	12.20	
7747	JDK T22	Beyaz	0.50 - 2.5 mm ²	13.0	43.0	13.4	50	2000	31.100	
7748	JDK T42	Beyaz	0.50 - 2.5 mm ²	23-13	31.5	13.5	50	2000	41.25	
7749	JDK - 42	Beyaz	0.50 - 2.5 mm ²	23-13	31.5	13.5	50	2000	15.90	
7750	JDK - 62	Beyaz	0.50 - 2.5 mm ²	33-13	31.5	13.5	40	2000	28.10	
7751	JDK - 63	Beyaz	0.50 - 2.5 mm ²	33-13	31.5	13.5	30	1000	29.90	
7751	JDK - 93	Beyaz	0.50 - 2.5 mm ²	48-28	31.5	3.5	30	1000	36.98	
7752	JRJ45- CAT6	Beyaz					100	1000	1.60	

YENİ
ÜRÜN



Jameson®

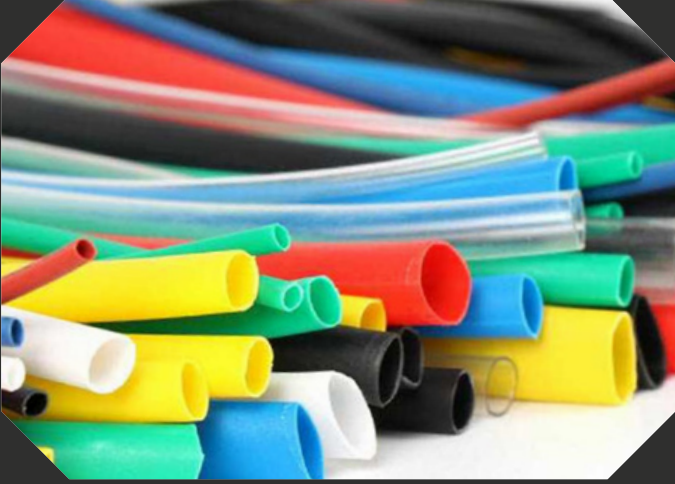

MAKARON ÇEŞİTLERİ ve KABLO TOPLAMA ÇORAPLARI



ISI İLE DARALAN SİYAH MAKARONLAR

Sipariş Kodu	Ölçü		Daralmadan Önce (mm)		Daralmadan Sonra (mm)		Makara / Mt.	Koli Miktarı	Birim Fiyatı USD / Mt.
	Inch	mm	İç Çap	Cidar Kalınlığı	İç Çap	Cidar Kalınlığı			
5015	—	1	2.0 ± 0.3	0.16 ± 0.05	0.70	0.30 ± 0.05	200	3200	0.085
5016	—	1.5	2.0 ± 0.3	0.16 ± 0.05	0.80	0.30 ± 0.05	200	2400	0.097
5017	—	2	2.5 ± 0.3	0.16 ± 0.05	1.00	0.35 ± 0.05	200	3000	0.115
5018	3/32	2.4	3.0 ± 0.3	0.16 ± 0.05	1.50	0.35 ± 0.05	200	3000	0.115
5019	—	2.5	3.0 ± 0.3	0.16 ± 0.05	1.25	0.38 ± 0.05	200	2600	0.15
5020	—	3	3.4 ± 0.4	0.20 ± 0.05	1.50	0.38 ± 0.05	200	2200	0.16
5021	1/8	3.2	3.5 ± 0.4	0.20 ± 0.05	1.75	0.40 ± 0.05	200	2200	0.16
5022	—	3.5	4.0 ± 0.4	0.20 ± 0.05	1.75	0.40 ± 0.05	200	1800	0.17
5023	—	4	4.5 ± 0.4	0.20 ± 0.05	2.00	0.45 ± 0.05	200	1400	0.20
5024	—	4.5	4.8 ± 0.4	0.20 ± 0.05	2.00	0.47 ± 0.08	100	1000	0.23
5025	3/16	4.8	5.2 ± 0.4	0.20 ± 0.05	2.60	0.47 ± 0.08	100	1000	0.23
5026	—	5	5.5 ± 0.4	0.20 ± 0.05	2.50	0.55 ± 0.08	100	900	0.25
5027	—	6	6.5 ± 0.4	0.22 ± 0.05	3.00	0.55 ± 0.05	100	700	0.29
5028	1/4	6.4	7.0 ± 0.4	0.28 ± 0.05	3.50	0.55 ± 0.08	100	700	0.29
5029	—	7	7.5 ± 0.4	0.28 ± 0.05	3.50	0.60 ± 0.08	100	500	0.35
5030	—	8	8.5 ± 0.4	0.30 ± 0.08	4.00	0.60 ± 0.08	100	1300	0.35
5031	3/8	9.5	10.0 ± 0.5	0.30 ± 0.08	5.00	0.60 ± 0.08	100	1200	0.35
5032	—	10	10.0 ± 0.5	0.30 ± 0.08	5.00	0.60 ± 0.08	100	1100	0.39
5033	1/2	12.7	13.0 ± 0.5	0.33 ± 0.10	6.50	0.65 ± 0.08	100	1000	0.45
5034	—	13	13.5 ± 0.5	0.33 ± 0.10	6.50	0.65 ± 0.08	100	900	0.48
5035	—	14	14.5 ± 0.5	0.33 ± 0.10	7.00	0.70 ± 0.08	100	900	0.56
5036	4/5	16	16.5 ± 0.6	0.35 ± 0.12	8.00	0.75 ± 0.08	100	800	0.75
5037	—	18	19.0 ± 0.6	0.40 ± 0.15	9.00	0.80 ± 0.15	100	700	0.98
5038	3/4	19.1	20.5 ± 0.6	0.40 ± 0.15	10.00	0.80 ± 0.15	100	700	0.98
5039	—	20	20.5 ± 0.6	0.40 ± 0.15	10.00	0.80 ± 0.15	100	600	1.25
5040	—	22	22.5 ± 0.7	0.45 ± 0.15	12.00	0.95 ± 0.15	100	600	1.55
5041	1	25.4	25.6 ± 0.7	0.45 ± 0.15	12.00	0.95 ± 0.15	50	300	1.65
5042	—	30	31.5 ± 0.7	0.50 ± 0.15	15.00	0.95 ± 0.15	50	250	2.15
5043	1 — 1/4	32	33.0 ± 0.7	0.50 ± 0.15	16.50	0.95 ± 0.15	50	250	2.15
5044	—	35	38.0 ± 0.7	0.50 ± 0.15	16.00	1.00 ± 0.15	50	200	2.70
5045	1 — 1/2	38	40.0 ± 0.7	0.50 ± 0.15	20.00	1.00 ± 0.15	50	200	3.00
5046	—	40	40.5 ± 0.7	0.50 ± 0.15	20.00	1.00 ± 0.15	50	200	3.00
5047	2	51	52.5 ± 0.7	0.50 ± 0.15	25.00	1.00 ± 0.15	25	125	3.80
5048	—	60	60.5 ± 0.8	0.52 ± 0.15	30.00	1.00 ± 0.16	25	100	5.10
5049	—	70	70.5 ± 1.0	0.55 ± 0.15	40.00	1.10 ± 0.18	25	75	6.80
5050	—	80	82.0 ± 1.0	0.55 ± 0.15	40.00	1.10 ± 0.18	25	75	7.50
5051	—	90	90.0 ± 1.0	0.55 ± 0.15	45.00	1.10 ± 0.18	25	50	9.50
5052	4	102	105.0 ± 1.0	0.55 ± 0.15	51.00	1.10 ± 0.18	25	50	9.50
5053	—	120	120.0 ± 1.0	0.55 ± 0.15	60.00	1.10 ± 0.18	25	50	13.00
5054	—	150	150.0 ± 1.0	0.55 ± 0.15	76.00	1.10 ± 0.18	25	50	19.00
5055	—	180	180.0 ± 1.0	0.55 ± 0.15	90.00	1.10 ± 0.18	25	25	27.00

ÇALIŞMA SICAKLIĞI: -55 °C «» +125 °C **MALZEME:** Polyolefin **Daralma Oranı:** 2/1 **Yanmazlık:** Kendi kendine söner



ISI İLE DARALAN RENKLİ MAKARONLAR

ŞEFFAF - BEYAZ - KIRMIZI - MAVİ - SARI - YEŞİL - GRİ

Ölçü		Sipariş Kodu								Makara / Mt.	Koli Miktarı	Fiyat USD / Mt.
Inch	mm	ŞEFFAF	BEYAZ	KIRMIZI	MAVİ	SARI	YEŞİL	GRİ				
—	1.5	5101	5117	5138	5154	5175	5195	5211	200	3.200	0.11	
—	2.5	5102	5118	5139	5155	5175	5196	5212	200	2.600	0.17	
1/8	3.2	5103	5119	5140	5156	5176	5197	5213	200	2.200	0.20	
—	3.5	—	5120	—	5157	5177	—	—	200	1.800	0.21	
Yassı	3.5	—	5121	—	5158	5178	—	—	100	1.600	0.21	
3/16	4.8	5104	5122	5141	5159	5179	5198	5214	100	1.000	0.27	
Yassı	4.8	—	5123	—	5160	5180	—	—	100	1.500	0.27	
1/4	6.4	5105	5124	5142	5161	5181	5199	5215	100	700	0.33	
Yassı	6.4	—	5125	—	5162	5182	—	—	100	1.500	0.33	
Yassı	7	—	5126	—	5163	5183	—	—	100	1.400	0.33	
3/8	9.5	5106	5127	5143	5164	5184	5200	5216	100	1.200	0.39	
—	13	5107	5128	5144	5165	5185	5201	5217	100	900	0.55	
4/5	16	5108	5129	5145	5166	5186	5202	5218	100	800	0.85	
—	20	5109	5130	5146	5167	5187	5203	5219	100	600	1.50	
1	25.4	5110	5131	5147	5168	5188	5204	5220	50	300	1.90	
1 - 1/4	32	5111	5132	5148	5169	5189	5205	5221	50	250	2.40	
1 - 1/2	38	5112	5133	5149	5170	5190	5206	5222	50	200	3.60	
2	51	5113	5134	5150	5171	5191	5207	5223	25	125	4.20	
—	60	5114	5135	5151	5172	5192	5208	5224	25	100	5.80	
—	80	5115	5136	5152	5173	5193	5209	5225	25	75	8.00	
4	102	5116	5137	5153	5174	5194	5210	5226	25	50	11.00	

TEKNİK ÖZELLİKLER

MALZEME: Polyolefin

NOMİNAL AKIM: 2/1

NOMİNAL GERİLİM: Kendi kendine söner

ÇALIŞMA SICAKLIĞI: -55 °C «» 125 °C



ISI İLE DARALAN RENKLİ MAKARONLAR

KAHVERENGİ- TURUNCU - MOR

Ölçü		Sipariş Kodu			Makara / Mt.	Koli Miktarı	Fiyat USD / Mt.
Inch	mm	KAHVERENGİ	TURUNCU	MOR			
—	1.5	5227	5243	5259	200	3.200	0.12
—	2.5	5228	5244	5260	200	2.600	0.18
1/8	3.2	5229	5245	5261	200	2.200	0.22
3/16	4.8	5230	5246	5262	100	1.000	0.27
1/4	6.4	5231	5247	5263	100	700	0.35
3/8	9.5	5232	5248	5264	100	1.200	0.42
—	13	5233	5249	5265	100	900	0.55
4/5	16	5234	5250	5266	100	800	1.00
—	20	5235	5251	5267	100	600	1.50
1	25.4	5236	5252	5268	50	300	2.00
1 - 1/4	32	5237	5253	5269	50	250	2.70
1 - 1/2	38	5238	5254	5270	50	200	4.00
2	51	5239	5255	5271	25	125	4.60
—	60	5240	5256	5272	25	100	7.20
—	80	5241	5257	5273	25	75	8.50
4	102	5242	5258	5274	25	50	12.50

TEKNİK ÖZELLİKLER

MALZEME: Polyolefin

NOMİNAL AKIM: 2/1

NOMİNAL GERİLİM: Kendi kendine söner

ÇALIŞMA SICAKLIĞI: -55 °C «» 125 °C



ISI İLE DARALAN MAKARONLAR

SARI YEŞİL

Sipariş Kodu	Ölçü		Daralmadan Önce (mm)		Daralmadan Sonra (mm)		Makara / Mt.	Koli Miktarı	Fiyat USD / Mt.
	Inch	mm	İç Çap	Cidar Kalınlığı	İç Çap	Cidar Kalınlığı			
5275	3/32	2.4	3.0 ± 0.3	0.16 ± 0.05	1.50	0.35 ± 0.05	200	3.000	0.42
5276	1/8	3.2	3.5 ± 0.4	0.20 ± 0.05	1.75	0.40 ± 0.05	200	2.200	0.43
5277	3/16	4.8	5.2 ± 0.4	0.20 ± 0.05	2.60	0.47 ± 0.08	100	1.000	0.44
5278	1/4	6.4	7.0 ± 0.4	0.28 ± 0.05	3.50	0.55 ± 0.08	100	700	0.50
5279	3/8	9.5	10.0 ± 0.5	0.30 ± 0.08	5.00	0.65 ± 0.08	100	1.200	0.68
5280	—	13	13.5 ± 0.5	0.33 ± 0.10	6.50	0.75 ± 0.08	100	900	1.00
5281	4/5	16	16.5 ± 0.6	0.35 ± 0.12	8.00	0.80 ± 0.15	100	800	1.45
5282	—	20	20.5 ± 0.6	0.40 ± 0.15	10.00	0.95 ± 0.15	100	600	1.90
5283	1	25.4	25.6 ± 0.7	0.45 ± 0.15	12.00	0.95 ± 0.15	50	300	2.75
5284	1 - 1/4	32	33.0 ± 0.7	0.50 ± 0.15	16.50	1.00 ± 0.15	50	250	3.70
5285	1 - 1/2	38	40.0 ± 0.7	0.50 ± 0.15	20.00	1.00 ± 0.15	50	200	5.00
5286	2	51	52.5 ± 0.7	0.50 ± 0.15	25.00	1.00 ± 0.15	50	125	7.00
5287	—	60	60.5 ± 0.8	0.52 ± 0.15	30.00	1.00 ± 0.16	25	100	10.00
5288	—	80	82.5 ± 1.0	0.55 ± 0.15	40.00	1.00 ± 0.18	25	75	15.00
5289	4	102	105.0 ± 1.0	0.55 ± 0.15	51.00	1.00 ± 0.18	25	50	23.00

TEKNİK ÖZELLİKLER

MALZEME: Polyolefin

NOMİNAL AKIM: 2/1

NOMİNAL GERİLİM: Kendi kendine söner

ÇALIŞMA SICAKLIĞI: -55 °C «» 125 °C



İÇİ YAPIŞKANLI BORU TİPİ MAKARONLAR

Sipariş Kodu	Ölçü	Daralmadan Önce (mm)		Daralmadan Sonra (mm)		Makara / Mt.	Koli Miktarı	Fiyat USD / Mt.
		İç Çap	Azami İç Çap	Anma Cıdar Kalınlığı	Anma Yapışkanlığı			
5290	3/1	3	1.00	1.10 ± 0.10	0.50	200	1.800	0,65
5291	4.8/1.5	4.8	1.50	1.20 ± 0.10	0.50	100	900	0,80
5292	6.2	6	2.00	1.30 ± 0.10	0.50	100	600	1.20
5293	9/3	9	3.00	1.70 ± 0.15	0.60	50	300	1.60
5294	12/4	12	4.00	2.00 ± 0.20	0.80	1.20 Boy	250	2,30
5295	16/5	16	5.00	2.20 ± 0.20	0.80	1.20 Boy	250	3.20
5296	19/6	19	6.00	2.30 ± 0.20	0.80	1.20 Boy	150	4.50
5297	28/9	28	9.00	2.40 ± 0.20	1.05	1.20 Boy	110	5.10
5298	33/10	33	10.00	2.50 ± 0.20	1.05	1.20 Boy	100	5.80
5299	40/12	40	12.00	2.50 ± 0.20	1.05	1.20 Boy	90	6.40
5300	44/14	44	14.00	2.50 ± 0.20	1.05	1.20 Boy	60	7.10
5301	52/18	52	18.00	2.50 ± 0.20	1.05	1.20 Boy	60	8.00
5302	70/25	70	25.00	3.00 ± 0.30	1.35	1.20 Boy	32	11.30
5303	90/30	90	30.00	3.00 ± 0.30	1.35	1.20 Boy	24	16.00
5304	125/40	125	40.00	3.00 ± 0.30	1.35	1.20 Boy	20	20.00

MAKARONLAR TEKNİK ÖZELLİKLER

MALZEME: Polyolefin

NOMİNAL AKIM: 3/1

NOMİNAL GERİLİM: Kendi kendine söner

ÇALIŞMA SICAKLIĞI: -45 °C «» 125 °C

İÇİ
YAPIŞKANLI
BORU
TİPİ

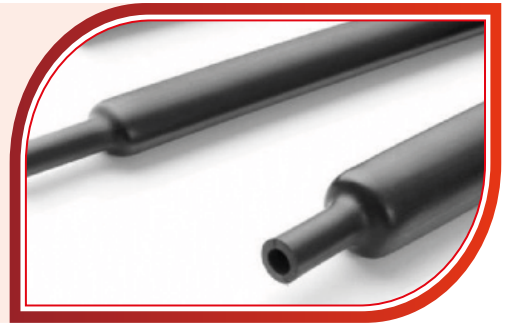

H CLASS CAM ELYAF SİLİKON İZOLELİ MAKARONLAR

Sipariş Kodu	Ölçü	Renk	Makara / Mt.	Koli Miktarı	Fiyat USD / Mt.
5401	1 mm	Kırmızı	200	2.600	0,22
5402	2 mm	Kırmızı	200	2.600	0.23
5403	3 mm	Kırmızı	100	2.000	0.35
5404	4 mm	Kırmızı	100	1.500	0.48
5405	5 mm	Kırmızı	100	1.000	0.55
5406	6 mm	Kırmızı	100	1.000	0.68
5407	7 mm	Kırmızı	100	1.000	0.80
5408	8 mm	Kırmızı	50	1.000	0.93
5409	10 mm	Kırmızı	50	600	1.25
5410	12 mm	Kırmızı	50	500	1.55
5411	14 mm	Kırmızı	50	500	1.85
5412	16 mm	Kırmızı	25	400	2.45
5413	18 mm	Kırmızı	25	400	3.20
5414	20 mm	Kırmızı	25	350	4.15
5415	25 mm	Kırmızı	25	150	7.85
5416	30 mm	Kırmızı	25	150	11.60
5417	35 mm	Kırmızı	25	150	13.75

TEKNİK ÖZELLİKLER

MALZEME: Silikon İzoleli Cam Elyaf Örgü Makaron

ÇALIŞMA SICAKLIĞI: -60 °C «» +250 °C



PVC İZOLELİ CAM ELYAF MAKARONLAR

Sipariş Kodu	Ölçü	Renk	Makara / Mt.	Koli Miktarı	Fiyat USD / Mt.
5501	1 mm	Beyaz Üzeri Çizgili	200	2.400	0.13
5502	2 mm	Beyaz Üzeri Çizgili	200	2.400	0.16
5503	3 mm	Beyaz Üzeri Çizgili	100	2.400	0.21
5504	4 mm	Beyaz Üzeri Çizgili	100	2.000	0.29
5505	5 mm	Beyaz Üzeri Çizgili	100	1.400	0.35
5506	6 mm	Beyaz Üzeri Çizgili	100	1.300	0.40
5507	7 mm	Beyaz Üzeri Çizgili	100	1.200	0.44
5508	8 mm	Beyaz Üzeri Çizgili	100	1.000	0.60
5509	10 mm	Beyaz Üzeri Çizgili	50	1.000	0.76
5510	12 mm	Beyaz Üzeri Çizgili	50	1.000	0.89
5511	14 mm	Beyaz Üzeri Çizgili	50	650	1.288
5512	16 mm	Beyaz Üzeri Çizgili	50	600	1.288
5513	18 mm	Beyaz Üzeri Çizgili	50	400	1.45
5514	20 mm	Beyaz Üzeri Çizgili	25	400	2.24

TEKNİK ÖZELLİKLER

MALZEME: PVC İzoleli Cam Elyaf Makaron

ÇALIŞMA SICAKLIĞI: -20 °C «» +130 °C



KABLO TOPLAMA ÇORABI

Sipariş Kodu	Ölçü	Renk	Esneleme Aralığı		Makara / Mt.	Fiyat USD / Mt.
			Min (mm)	Max (mm)		
5601	3 mm	Siyah	1	6	100	0.23
5602	6 mm	Siyah	3	9	100	0.27
5603	8 mm	Siyah	5	16	100	0.28
5604	10 mm	Siyah	7	19	100	0.34
5605	12 mm	Siyah	8	24	100	0.40
5606	15 mm	Siyah	10	27	100	0.46
5607	20 mm	Siyah	14	30	100	0.53
5608	25 mm	Siyah	18	35	100	0.68
5609	30 mm	Siyah	20	50	50	0.82
5610	40 mm	Siyah	30	60	50	1.10
5611	50 mm	Siyah	40	80	25	1.30

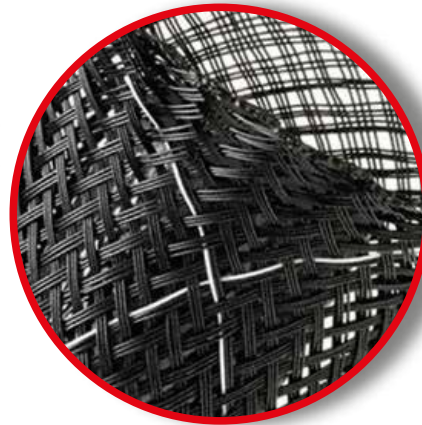

TEKNİK ÖZELLİKLER

MALZEME: Pet (Polyester)

ÇALIŞMA SICAKLIĞI: -50 °C «» +150 °C

DAYANIM ÜST NOKTASI: 220 °C

ERİME NOKTASI: +250 °C



JAMESON®



MEKANİK VE HİDROLİK EL ALETLERİ

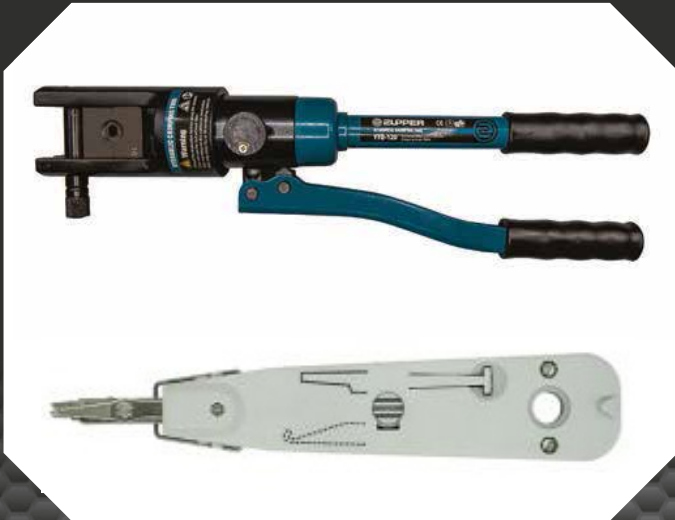

www.kivilcimelektrik.com.tr

YÜKSÜK SIKMA PENSELERİ / MEKANİK EL ALETLERİ

Sipariş Kodu: 6001

T-007

0.5-10 mm² Yüksük Sıkma Pensesi



135.00
USD

Sipariş Kodu: 6002

AN-03C

0.5-6 mm² Yüksük Sıkma Pensesi



60.00
USD

Sipariş Kodu: 6003

AN-004

0.5-10 mm² İzolesiz Kablo Ucu Sıkma Pensesi



60.00
USD

Sipariş Kodu: 6004

AN-04WFL

0.5-6 mm² Yüksük Sıkma Pensesi



69.00
USD

Sipariş Kodu: 6005

AN-006

0.5-6 mm² İzoleli Kablo Ucu Sıkma Pensesi



52.00
USD

Sipariş Kodu: 6006

AN-10

1.5-10 mm² İzolesiz Kablo Ucu Sıkma Pensesi



65.00
USD



Sipariş Kodu: 6007

AP-006

0.5-6 mm² İzoleli Kablo Ucu Sıkma Pensesi



71.00
USD

Sipariş Kodu: 6008

AN-16WF

1-16 mm² İzoleli Kablo Ucu Sıkma Pensesi



57.00
USD

Sipariş Kodu: 6009

AN-35WF

10-35 mm² İzoleli Kablo Ucu Sıkma Pensesi



63.00
USD

Sipariş Kodu: 6010

HSC8 6-4A

0.25-6 mm² İzoleli Kablo Ucu Sıkma Pensesi



85.00
USD

Sipariş Kodu: 6011

HSC8 6-6

0.25-6 mm² İzoleli Kablo Ucu Sıkma Pensesi



100.00
USD

Sipariş Kodu: 6012

HSC8 16-4

4-16 mm² İzoleli Kablo Ucu Sıkma Pensesi



100.00
USD

KABLO SIYIRICILARI / MEKANİK EL ALETLERİ

Sipariş Kodu: 6013

HS-2204

Kablo Sıyrıcı



25.00
USD

Sipariş Kodu: 6014

ST700D

Kablo Sıyrıcı



25.00
USD

Sipariş Kodu: 6015

HY-369A

0.5-2 mm² Tekli Kablo Sıyrma Pensesi



37.00
USD

Sipariş Kodu: 6016

HY-369B

1.0-3.2 mm² Tekli Kablo Sıyrma Pensesi



37.00
USD

Sipariş Kodu: 6017

G-2096C

6 PIN Konnektör Sıkma Pensesi

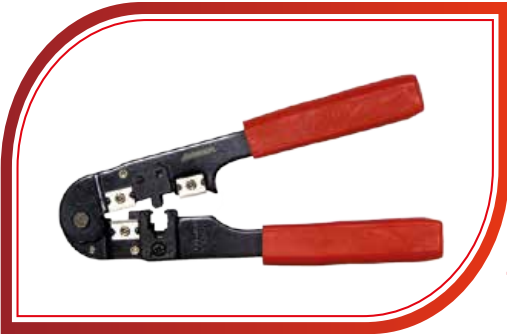

49.00
USD



Sipariş Kodu: 6018

HT-210C

8 PIN Konnektör Sıkma Pensesi



49.00
USD



Sipariş Kodu: 6019

JEA-CT468ST

4-6-8 (Testli) Konnektör Sıkma Pensesi



YENİ
ÜRÜN

99.00
USD



Sipariş Kodu: 6020

G-376E

6-8 PIN Konnektör Sıkma Pensesi



60.00
USD



Sipariş Kodu:7753

JEA-ST766K

Kablo Sıyırıcı ve Yüzük Sıkma Pensesi



60.00
USD

Sipariş Kodu:7754

JEA-ST766S

Kablo Sıyırıcı ve Yüzük Sıkma Pensesi



60.00
USD

Sipariş Kodu:7755

PT3141

Telefon Krone Kep Kep Pense



9.00
USD

Sipariş Kodu:7756

JEA-CT315

6-8 PIN Konnektör Sıkma Pensesi



60.00
USD



KABLO KESME MAKASLARI

Sipariş Kodu: 6022

TC- 100

120 mm² Kablo Kesme Makası



70.00
USD

Sipariş Kodu: 6023

TC-250

250 mm² Kablo Kesme Makası



135.00
USD

Sipariş Kodu: 6025

TC-500

630 mm² Kablo Kesme Makası



195.00
USD

Sipariş Kodu: 6029

LK-22A

22 - 160 mm² Kablo Kesme Makası



33.00
USD

Sipariş Kodu: 6028

LK-38A

38- 210 mm² Kablo Kesme Makası

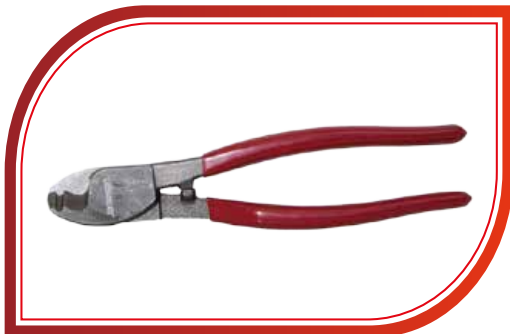

37.00
USD

Sipariş Kodu: 6027

LK-60A

60 - 230 mm² Kablo Kesme Makası

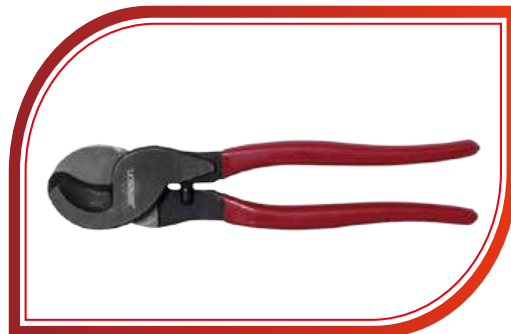

42.00
USD

KABLO PABUCU MEKANİK VE HİDROLİK SIKMA PENSELERİ

Sipariş Kodu: 6031

JY-0650

6 - 50 mm² SKP Sıkma Pensesi



82.00
USD

Sipariş Kodu: 6032

JY-06120

0.6 - 120 mm² SKP Sıkma Pensesi



165.00
USD

Sipariş Kodu: 6033

JY-25150

25 - 150 mm² SKP Sıkma Pensesi

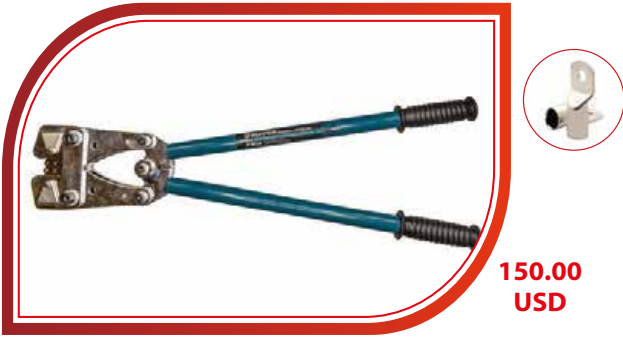

150.00
USD

Sipariş Kodu: 6034

YQK-120

10 - 120 mm² Hidrolik SKP Sıkma Pensesi (Çantalı Set)

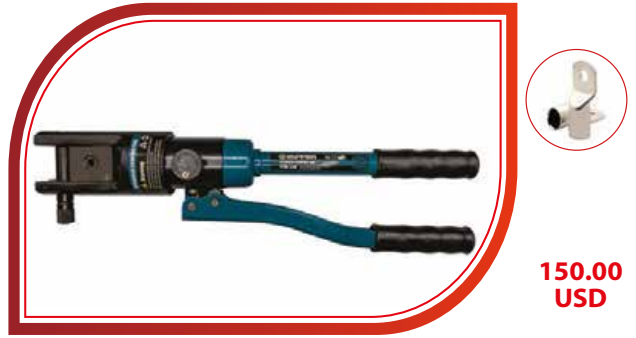

150.00
USD

Sipariş Kodu: 6035

YQK-300

16 - 300 mm² Hidrolik SKP Sıkma Pensesi (Çantalı Set)



160.00
USD

Sipariş Kodu: 6036

YQK-70

10 - 70 mm² Hidrolik SKP Sıkma Pensesi (Çantalı Set)



120.00
USD

KABLO KESME MAKASLARI

Sipariş Kodu: 6026

TCR-325

325 mm² Bakır ve Alüminyum Kablo Kesme Makası



**195.00
USD**

Sipariş Kodu: 6024

ZC-52A

500 mm² Çok Telli Kablo Kesme Makası



**325.00
USD**

Sipariş Kodu: 6030

ZC-60A

500 mm² Bakır ve Alüminyum Kablo Kesme Makası



**240.00
USD**

Sipariş Kodu: 6039

AN-103

1.0-6 mm² Kablo Kapama Pensesi



**66.00
USD**

Sipariş Kodu: 6040

HD-50L

5.5 - 50 mm² Yüksük Sıkma Pensesi



**95.00
USD**

Sipariş Kodu: 6041

T03C-5D

AN-04WFL Yüksük Sıkma 0.5 - 6 mm
AN-16WF Yüksük Sıkma 6 - 16 mm
AN-006 Kablo Ucu Sıkma 0.5 - 6 mm
AN-03B İzolesiz Terminal Sıkma 1 - 4 mm
AN-004 Kaynaklı Papuç Sıkma 0.5 - 10 mm

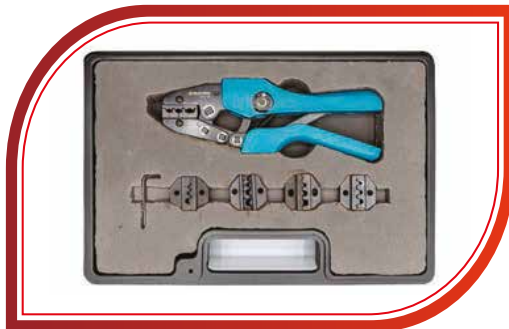

**160.00
USD**



JAMESON®



BUTON VE AKSESUARLARI

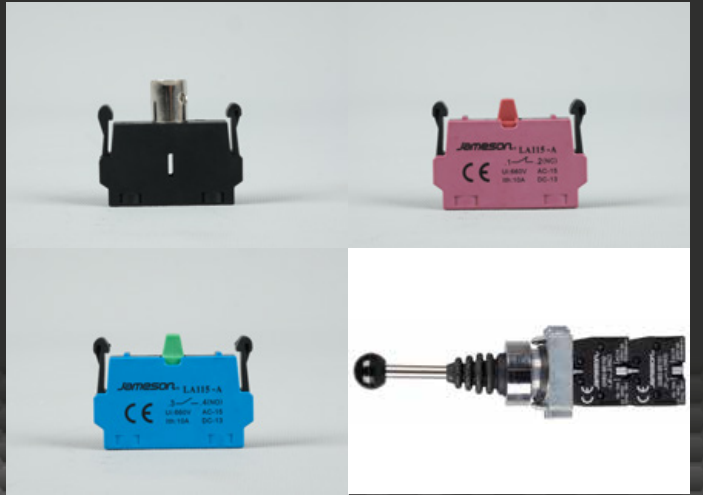

www.kivilcimelektrik.com.tr

YAYLI BUTONLAR

Sipariş Kodu	Ürün Kodu	Kontak	Açıklama	Renk	Kutu Adet	Koli Adet	Fiyat TL. / AD.
7001	A1 - 10	1NO	Yaylı Buton	Yeşil	10	300	44.00
7002	A1 - 01	1NC	Yaylı Buton	Kırmızı	10	300	44.00
7003	A1 - 11	1NO	Yaylı Buton	Sarı	10	300	44.00
7004	A1 - 21	1NO	Yaylı Buton	Mavi	10	300	44.00
7005	A1 - 31	1NO	Yaylı Buton	Beyaz	10	300	44.00
7006	A1 - 41	1NO	Yaylı Buton	Siyah	10	300	44.00



İŞARETLİ YAYLI BUTONLAR

7007	A1 - 10/1	1NO	İşaretlili Yaylı Buton	Yeşil	10	300	52.00
7008	A1 - 01/2	1NC	İşaretlili Yaylı Buton	Kırmızı	10	300	52.00
7009	A1 - 10/3	1NO	İşaretlili Yaylı Buton	Sarı	10	300	52.00
7010	A1 - 10/4	1NO	İşaretlili Yaylı Buton	Mavi	10	300	52.00



İŞIKLI YAYLI BUTONLAR

7011	A1 - 10D	1NO	Işıklı Yaylı Buton 220V AC/DC	Yeşil	10	300	83.00
7012	A1 - 01D	1NC		Kırmızı	10	300	83.00
7013	A1 - 11D	1NO		Sarı	10	300	83.00
7014	A1 - 21D	1NO		Mavi	10	300	83.00
7015	A1 - 31D	1NO		Beyaz	10	300	83.00
7016	A1 - 10D - 110	1NO	Işıklı Yaylı Buton 110V AC/DC	Yeşil	10	300	83.00
7017	A1 - 01D - 110	1NC		Kırmızı	10	300	83.00
7018	A1 - 11D - 110	1NO		Sarı	10	300	83.00
7019	A1 - 21D - 110	1NO		Mavi	10	300	83.00
7020	A1 - 31D - 110	1NO		Beyaz	10	300	83.00
7021	A1 - 10D - 24	1NO	Işıklı Yaylı Buton 24V AC/DC	Yeşil	10	300	83.00
7022	A1 - 01D - 24	1NC		Kırmızı	10	300	83.00
7023	A1 - 11D - 24	1NO		Sarı	10	300	83.00
7024	A1 - 21D - 24	1NO		Mavi	10	300	83.00
7025	A1 - 31D - 24	1NO		Beyaz	10	300	83.00





İKİZ BUTONLAR

7026	A1 - 11R	1NO + 1NC	İkiz Buton	Yeşil - Kırmızı	10	300	85.00
7027	A1 - 11RD	1NO + 1NC	Işıklı İkiz Buton 220 V AC/DC	Yeşil - Kırmızı	10	300	115.00
7028	A1 - 11RD - 110	1NO + 1NC	Işıklı İkiz Buton 110 V AC/DC	Yeşil - Kırmızı	10	300	115.00
7029	A1 - 11RD - 24	1NO + 1NC	Işıklı İkiz Buton 24 V AC/DC	Yeşil - Kırmızı	10	300	115.00



Q 22mm BUTON SERİSİ KALICI MANDAL BUTONLAR

Sipariş Kodu	Ürün Kodu	Kontakt	Açıklama	Kutu Adet	Koli Adet	Fiyat TL. / AD.
7030	A1 - 10X	1NO	0-1 Mandal Buton 	10	300	50.00
7031	A1 - 20XS	2NO	1-0-2 Mandal Buton 	10	300	68.00



KAYICI MANDAL BUTONLAR

Sipariş Kodu	Ürün Kodu	Kontakt	Açıklama	Kutu Adet	Koli Adet	Fiyat TL. / AD.
7032	A1 - 10X / FU	1NO	0-1 Mandal Buton 	10	300	55.00
7033	A1 - 20XS / FU	2NO	1-0-2 Mandal Buton 	10	300	75.00



ANAHTARLI KALICI & KAYICI BUTONLAR

Sipariş Kodu	Ürün Kodu	Kontakt	Açıklama	Kutu Adet	Koli Adet	Fiyat TL. / AD.
7034	A1 - 10Y	1NO	0-1 Anahtarlı Buton 	10	300	75.00
7035	A1 - 10Y / FU	1NO	0-1 Anahtarlı Buton 	10	300	88.00
7744	A1 - 20YS	2NO	1-0-2 Anahtarlı Buton 	10	300	98.00



KALICI - KAYICI MANDAL BUTON





































Sipariş Kodu	Ürün Kodu	Açıklama	Kutu Adet	Koli Adet	Fiyat TL. / AD.
7072	A1-20XS/F	1-0-2 Mandal Buton Sağ Pozisyon Kalıcı Sol Pozisyon Kayıcı	10	300	75.00

JOYSTICK VİNÇ BUTONLAR
KALICI VE KAYICI

Sipariş Kodu	Ürün Kodu	Açıklama	Kutu Adet	Koli Adet	Fiyat TL. / AD.
7036	LA155-PA12	2 YÖNLÜ KAYICI JOYSTİK	10	300	188.00
7037	LA155-PA14	4 YÖNLÜ KAYICI JOYSTİK	10	300	217.00
7073	LA155-PA22	2 YÖNLÜ KALICI JOYSTİK	10	300	188.00
7074	LA155-PA24	4 YÖNLÜ KALICI JOYSTİK	10	300	217.00



Q 22mm BUTON SERİSİ

Sipariş Kodu	Ürün Kodu	Kontakt	Açıklama	Renk	Kutu Adet	Koli Adet	Fiyat TL. / AD.
7038	A1 - 10XD	1NO		 Yeşil	10	300	82.00
7039	A1 - 01XD	1NC		 Kırmızı	10	300	82.00
7040	A1 - 11XD	1NO	0-1 Işıklı Mandal Buton 220V AC/DC	 Sarı	10	300	82.00
7041	A1 - 21XD	1NO		 Mavi	10	300	82.00
7042	A1 - 10XD - 110	1NO		 Yeşil	10	300	82.00
7043	A1 - 01XD - 110	1NC		 Kırmızı	10	300	82.00
7044	A1 - 11XD - 110	1NO	0-1 Işıklı Mandal Buton 110V AC/DC	 Sarı	10	300	82.00
7046	A1 - 21XD - 110	1NO		 Mavi	10	300	82.00
7047	A1 - 10XD - 24	1NO		 Yeşil	10	300	82.00
7048	A1 - 01XD - 24	1NC		 Kırmızı	10	300	82.00
7049	A1 - 21XD - 24	1NO	0-1 Işıklı Mandal Buton 24V AC/DC	 Sarı	10	300	82.00
7050	A1 - 31XD - 24	1NO		 Mavi	10	300	82.00
7051	A1 - 20XSD	2NO		 Yeşil	10	300	100.00
7052	A1 - 02XSD	2NC		 Kırmızı	10	300	100.00
7053	A1 - 21XSD	2NO	1-0-2 Işıklı Mandal Buton 220V AC/DC	 Sarı	10	300	100.00
7054	A1 - 31XSD	2NO		 Mavi	10	300	100.00
7055	A1 - 20XSD - 110	2NO		 Yeşil	10	300	100.00
7056	A1 - 02XSD - 110	2NC		 Kırmızı	10	300	100.00
7057	A1 - 21XSD - 110	2NO	1-0-2 Işıklı Mandal Buton 110V AC/DC	 Sarı	10	300	100.00
7058	A1 - 31XSD - 110	2NO		 Mavi	10	300	100.00
7059	A1 - 20XSD - 24	2NO		 Yeşil	10	300	100.00
7060	A1 - 02XSD - 24	2NC		 Kırmızı	10	300	100.00
7061	A1 - 21XSD - 24	2NO	1-0-2 Işıklı Mandal Buton 24V AC/DC	 Sarı	10	300	100.00
7062	A1 - 31XSD - 24	2NO		 Mavi	10	300	100.00



Q 22mm BUTON SERİSİ 40 mm KALICI MANTAR BUTON

Sipariş Kodu	Ürün Kodu	Kontakt	Açıklama	Renk	Kutu Adet	Koli Adet	Fiyat TL. / AD.
7063	A1 - 01ZS	1NC	Stop Mantar Button	● Kırmızı	10	300	58.00



40 mm KALICI ANAHTARLI MANTAR BUTON

Sipariş Kodu	Ürün Kodu	Kontakt	Açıklama	Renk	Kutu Adet	Koli Adet	Fiyat TL. / AD.
7064	A1 - 01ZA	1NC	Anahtarlı Stop Mantar Button	● Kırmızı	10	300	85.00



40mm KAYICI MANTAR BUTONLAR

Sipariş Kodu	Ürün Kodu	Kontakt	Açıklama	Renk	Kutu Adet	Koli Adet	Fiyat TL. / AD.
7065	A1 - 01M	1NC	Stop Mantar Buton	● Kırmızı	10	300	53.00
7066	A1 - 10M	1NO	Stop Mantar Buton	● Yeşil	10	300	53.00
7067	A1 - 41M	1NO	Stop Mantar Buton	● Siyah	10	300	53.00



40mm KALICI MANTAR BUTONLAR

Sipariş Kodu	Ürün Kodu	Kontakt	Açıklama	Renk	Kutu Adet	Koli Adet	Fiyat TL. / AD.
7069	A1 - 01ZF	1NC	Stop Mantar Buton	● STOP	10	300	102.00
7069	A1 - 01ZFD	1NC	Led Işıklı Stop Mantar Buton 220V AC/DC	● STOP	10	300	130.00
7070	A1 - 01ZFD - 110	1NC	Led Işıklı Stop Mantar Buton 110V AC/DC	● STOP	10	300	130.00
7071	A1 - 01ZFD - 24	1NC	Led Işıklı Stop Mantar Buton 24V AC/DC	● STOP	10	300	130.00



BUTON AKSESUARLARI

Sipariş Kodu	Ürün Kodu	Açıklama	Kutu Adet	Fiyat TL. / AD.
7101	A - 10	1NO Start Kontak	50	18.00
7102	A- 01	1N C Stop Kontak	50	18.00
7103	A - D2	BA9S Led Kontak Yuvası (Buton için)	200	22.00
7104	XB2-EH2201	Plastik Buton Rozeti	100	2.70
7105	XB2-EH2208	Plastik Buton Rozeti	100	2.70
7106	XB2-ER60	60mm Acil Stop Etiketi	100	8.10
7107	XB2-EC2	Acil Stop Butonu Koruma Kapağı	20	44.00
7108	XB2-EB40P	Buton Koruma Kapağı	5	37.00
7109	XB2-PE16A	Buton Koruma Kılıfı	100	5.90
7110	XB2-EC3	Acil Stop Butonu Koruma Kapağı	10	40.00
7111	XB2-PE22CF	İkiz Buton Koruma Kılıfı	100	19.50



BOŞ BUTON KUTULARI

Sipariş Kodu	Ürün Kodu	Açıklama	Renk	Kutu Adet	Koli Adet	Fiyat TL. / AD.
7201	JBK 1 - SR	1'li Boş Kumanda Kutusu	Sarı - Siyah	1	100	31.00
7202	JBK 1 - GR	1'li Boş Kumanda Kutusu	Gri - Siyah	1	100	31.00
7203	JBK 2 - SR	2'li Boş Kumanda Kutusu	Sarı - Siyah	1	100	37.00
7204	JBK 2 - GR	2'li Boş Kumanda Kutusu	Gri - Siyah	1	100	37.00
7205	JBK 3 - SR	3'li Boş Kumanda Kutusu	Sarı - Siyah	1	100	47.00
7206	JBK 3 - GR	3'li Boş Kumanda Kutusu	Gri - Siyah	1	100	47.00
7207	JBK 4 - SR	4'lü Boş Kumanda Kutusu	Sarı - Siyah	1	50	60.00
7208	JBK 4 - GR	4'lü Boş Kumanda Kutusu	Gri - Siyah	1	50	60.00
7209	JBK 5 - SR	5'li Boş Kumanda Kutusu	Sarı - Siyah	1	50	90.00
7210	JBK 5 - GR	5'li Boş Kumanda Kutusu	Gri - Siyah	1	50	90.00
7211	JBK 6 - SR	6'lı Boş Kumanda Kutusu	Sarı - Siyah	1	50	90.00
7212	JBK6 - GR	6'lı Boş Kumanda Kutusu	Gri - Siyah	1	50	90.00



KUTULU ACİL STOP BUTON

Sipariş Kodu	Ürün Kodu	Kontakt	Açıklama	Renk	Kutu Adet	Koli Adet	Fiyat TL. / AD.
7213	JK-ASB	NC	1'li Mantar Acil Stop Buton	Sarı - Siyah	1	100	68.00



Ø 22mm VOLTMETRE

Sipariş Kodu	Ürün Kodu	Çap (mm)	Açıklama	Renk	Kutu Adet	Koli Adet	Fiyat TL / AD.
7301	AD-136-22DSV-K	22	24-550V Led'li Voltmetre	● Kırmızı	10	500	75.00
7302	AD-136-22DSV-Y	22	24-550V Led'li Voltmetre	● Yeşil	10	500	75.00
7303	AD-136-22DSV-S	22	24-550V Led'li Voltmetre	● Sarı	10	500	75.00
7304	AD-136-22DSV-M	22	24-550V Led'li Voltmetre	● Mavi	10	500	75.00
7305	AD-136-22DSV-B	22	24-550V Led'li Voltmetre	○ Beyaz	10	500	75.00



Ø 22mm AMPERMETRE

Sipariş Kodu	Ürün Kodu	Çap (mm)	Açıklama	Renk	Kutu Adet	Koli Adet	Fiyat TL / Mt.
7306	AD-136-22DSA-K	22	0-100 A Led'li Ampermetre Akım Trafolu	● Kırmızı	5	300	135.00
7307	AD-136-22DSA-Y	22	0-100 A Led'li Ampermetre Akım Trafolu	● Yeşil	5	300	135.00
7308	AD-136-22DSA-S	22	0-100 A Led'li Ampermetre Akım Trafolu	● Sarı	5	300	135.00
7309	AD-136-22DSA-M	22	0-100 A Led'li Ampermetre Akım Trafolu	● Mavi	5	300	135.00
7310	AD-136-22DSA-B	22	0-100 A Led'li Ampermetre Akım Trafolu	○ Beyaz	5	300	135.00



Ø 22mm LED'Lİ SİNYALLER

Sipariş Kodu	Ürün Kodu	Çap (mm)	Açıklama	Renk	Kutu Adet	Koli Adet	Fiyat TL. / AD.
7311	AD136-22DS-K	22	Led Sinyal 220V AC/DC	● Kırmızı	10	500	17.00
7312	AD136-22DS-Y	22	Led Sinyal 220V AC/DC	● Yeşil	10	500	17.00
7313	AD136-22DS-S	22	Led Sinyal 220V AC/DC	● Sarı	10	500	17.00
7314	AD136-22DS-M	22	Led Sinyal 220V AC/DC	● Mavi	10	500	17.00
7315	AD136-22DS-B	22	Led Sinyal 220V AC/DC	○ Beyaz	10	500	22.00
7316	AD136-22DS-110-K	22	Led Sinyal 110V AC/DC	● Kırmızı	10	500	17.00
7317	AD136-22DS-110-Y	22	Led Sinyal 110V AC/DC	● Yeşil	10	500	17.00
7318	AD136-22DS-110-S	22	Led Sinyal 110V AC/DC	● Sarı	10	500	17.00
7319	AD136-22DS-110-M	22	Led Sinyal 110V AC/DC	● Mavi	10	500	17.00
7320	AD136-22DS-110-B	22	Led Sinyal 110V AC/DC	○ Beyaz	10	500	22.00
7321	AD136-22DS-24-K	22	Led Sinyal 24V AC/DC	● Kırmızı	10	500	17.00
7322	AD136-22DS-24-Y	22	Led Sinyal 24V AC/DC	● Yeşil	10	500	17.00
7323	AD136-22DS-24-S	22	Led Sinyal 24V AC/DC	● Sarı	10	500	17.00
7324	AD136-22DS-24-M	22	Led Sinyal 24V AC/DC	● Mavi	10	500	17.00
7325	AD136-22DS-24-B	22	Led Sinyal 24V AC/DC	○ Beyaz	10	500	22.00

Ø 16mm LED'Lİ SİNYALLER

Sipariş Kodu	Ürün Kodu	Çap (mm)	Açıklama	Renk	Kutu Adet	Koli Adet	Fiyat TL. / AD.
7326	AD136-16DS-K	16	Led Sinyal 220V AC/DC	● Kırmızı	20	1000	25.00
7327	AD136-16DS-Y	16	Led Sinyal 220V AC/DC	● Yeşil	20	1000	25.00
7328	AD136-16DS-S	16	Led Sinyal 220V AC/DC	● Sarı	20	1000	25.00
7329	AD136-16DS-M	16	Led Sinyal 220V AC/DC	● Mavi	20	1000	25.00
7330	AD136-16DS-B	16	Led Sinyal 220V AC/DC	○ Beyaz	20	1000	32.00
7331	AD136-16DS-110-K	16	Led Sinyal 110V AC/DC	● Kırmızı	20	1000	32.00
7332	AD136-16DS-110-Y	16	Led Sinyal 110V AC/DC	● Yeşil	20	1000	32.00
7333	AD136-16DS-110-S	16	Led Sinyal 110V AC/DC	● Sarı	20	1000	32.00
7334	AD136-16DS-110-M	16	Led Sinyal 110V AC/DC	● Mavi	20	1000	32.00
7335	AD136-16DS-110-B	16	Led Sinyal 110V AC/DC	○ Beyaz	20	1000	32.00
7336	AD136-16DS-24-K	16	Led Sinyal 24V AC/DC	● Kırmızı	20	1000	32.00
7337	AD136-16DS-24-Y	16	Led Sinyal 24V AC/DC	● Yeşil	20	1000	32.00
7338	AD136-16DS-24-S	16	Led Sinyal 24V AC/DC	● Sarı	20	1000	32.00
7339	AD136-16DS-24-M	16	Led Sinyal 24V AC/DC	● Mavi	20	1000	32.00
7340	AD136-16DS-24-B	16	Led Sinyal 24V AC/DC	○ Beyaz	20	1000	32.00



BA9S LED AMPULLER

Sipariş Kodu	Ürün Kodu	Açıklama	Renk	Kutu Adet	Koli Adet	Fiyat TL. / AD.
7341	BA9SC - K	Led Ampul 220V AC/DC	● Kırmızı	50	4.000	18,50
7342	BA9SC - Y	Led Ampul 220V AC/DC	● Yeşil	50	4.000	18,50
7343	BA9SC - S	Led Ampul 220V AC/DC	● Sarı	50	4.000	18,50
7344	BA9SC - M	Led Ampul 220V AC/DC	● Mavi	50	4.000	18,50
7345	BA9SC - B	Led Ampul 220V AC/DC	○ Beyaz	50	4.000	22,00
7346	BA9SC - 110V - K	Led Ampul 220V AC/DC	● Kırmızı	50	4.000	22,00
7347	BA9SC - 110V - Y	Led Ampul 220V AC/DC	● Yeşil	50	4.000	22,00
7348	BA9SC - 110V - S	Led Ampul 220V AC/DC	● Sarı	50	4.000	22,00
7349	BA9SC - 110V - M	Led Ampul 220V AC/DC	● Mavi	50	4.000	22,00
7350	BA9SC - 110V - B	Led Ampul 220V AC/DC	○ Beyaz	50	4.000	22,00
7351	BA9SC - 24V - K	Led Ampul 220V AC/DC	● Kırmızı	50	4.000	22,00
7352	BA9SC - 24V - Y	Led Ampul 220V AC/DC	● Yeşil	50	4.000	22,00
7353	BA9SC - 24V - S	Led Ampul 220V AC/DC	● Sarı	50	4.000	22,00
7354	BA9SC - 24V - M	Led Ampul 220V AC/DC	● Mavi	50	4.000	22,00
7355	BA9SC - 24V - B	Led Ampul 220V AC/DC	○ Beyaz	50	4.000	22,00



METAL LEDLİ SİNYALLER

Sipariş Kodu	Ürün Kodu	Çap (mm)	Açıklama	Renk	Kutu Adet	Koli Adet	Fiyat TL. / AD.
7401	J8-220-K	8	Metal Led Sinyal 220V. AC-DC	● Kırmızı	50	600	18.00
7402	J8-220-Y	8		● Yeşil	50	600	18.00
7403	J8-220-SR	8		● Sarı	50	600	18.00
7404	J8-220-M	8		● Mavi	50	600	18.00
7405	J8-220-B	8		○ Beyaz	50	600	18.00
7406	J8-24-K	8	Metal Led Sinyal 24V. AC-DC	● Kırmızı	50	600	18.00
7407	J8-24-Y	8		● Yeşil	50	600	18.00
7408	J8-24-SR	8		● Sarı	50	600	18.00
7409	J8-24-M	8		● Mavi	50	600	18.00
7410	J8-24-B	8		○ Beyaz	50	600	21.00
7411	J10-220-K	10	Metal Led Sinyal 220V. AC-DC	● Kırmızı	30	360	21.00
7412	J10-220-Y	10		● Yeşil	30	360	21.00
7413	J10-220-SR	10		● Sarı	30	360	21.00
7414	J10-220-M	10		● Mavi	30	360	21.00
7415	J10-220-B	10		○ Beyaz	30	360	21.00
7416	J10-24-K	10	Metal Led Sinyal 24V. AC-DC	● Kırmızı	30	360	21.00
7417	J10-24-Y	10		● Yeşil	30	360	21.00
7418	J10-24-SR	10		● Sarı	30	360	21.00
7419	J10-24-M	10		● Mavi	30	360	21.00
7420	J10-24-B	10		○ Beyaz	30	360	21.00
7421	J14-220-K	14	Metal Led Sinyal 220V. AC-DC	● Kırmızı	15	180	21.00
7422	J14-220-Y	14		● Yeşil	15	180	21.00
7423	J14-220-SR	14		● Sarı	15	180	21.00
7424	J14-220-M	14		● Mavi	15	180	21.00
7425	J14-220-B	14		○ Beyaz	15	180	21.00
7426	J14-24-K	14	Metal Led Sinyal 24V. AC-DC	● Kırmızı	15	180	21.00
7427	J14-24-Y	14		● Yeşil	15	180	21.00
7428	J14-24-SR	14		● Sarı	15	180	21.00
7431	J14-24-M	14		● Mavi	15	180	21.00
7432	J14-24-B	14		○ Beyaz	15	180	21.00



BUZZERLAR Ø 22mm LEDLİ BUZZER

Sipariş Kodu	Ürün Kodu	Çap (mm)	Açıklama	Renk	Kutu Adet	Koli Adet	Fiyat TL. / AD.
7433	22DS/MS	22	Sesli Led Flaşör İkazlı 220 V. AC/DC	● Kırmızı	10	500	66.00
7434	22DS-MS110	22	Sesli Led Flaşör İkazlı 110V. AC/DC	● Kırmızı	10	500	66.00
7435	22DS/MS24	22	Sesli Led Flaşör İkazlı 24V. AC/DC	● Kırmızı	10	500	66.00
7451	22DS/MS12	22	Sesli Led Flaşör İkazlı 12V. AC/DC	● Kırmızı	10	500	66.00



Ø 22mm SESLİ BUZZER

Sipariş Kodu	Ürün Kodu	Çap (mm)	Açıklama	Renk	Kutu Adet	Koli Adet	Fiyat TL. / AD.
7436	22DS/M	22	Sesli İkazlı 220V. AC/DC	● Siyah	10	500	50.00
7437	22DS/M24	22	Sesli İkazlı 24V. AC/DC	● Siyah	10	500	50.00
7438	22DS-M110	22	Sesli İkazlı 110V. AC/DC	● Siyah	10	500	50.00



MOTORLU SİRENLER

Sipariş Kodu	Ürün Kodu	Açıklama	Kutu Adet	Koli Adet	Fiyat TL. / AD.
7439	MS-190/220V	75mm Metal Gövde 220 V. AC (110 - 130dB)	1	40	285.00
7440	MS-190/24V	75mm Metal Gövde 24 V. AC (110 - 130dB)	1	40	285.00
7441	MS-290/220V	110mm Metal Gövde 220AC (110-130dB)	1	40	415.00
7442	MS-290/24V	110mm Metal Gövde 24V (110-130dB)	1	40	415.00



ELEKTRONİK SİRENLER

Sipariş Kodu	Ürün Kodu	Açıklama	Kutu Adet	Koli Adet	Fiyat TL. / AD.
7443	ES-50-12/24	Plastik Gövde 120dB 12-24V. AC/DC	1	100	120.00
7444	ES-60-220	Plastik Gövde 120dB 220V. AC	1	100	204.00
7445	ES-60-12/24	Plastik Gövde 120dB 12-24V. AC	1	100	204.00



Ø 22mm POTANSİYOMETRE

Sipariş Kodu	Ürün Kodu	Çap (mm)	Açıklama	Kutu Adet	Koli Adet	Fiyat TL. / AD.
7446	JPT-5K	22	5K Potansiyometre Tek Turlu 220 V. AC	10	500	120.00
7447	JPT-10K	22	10K Potansiyometre Tek Turlu 220 V. AC	10	500	120.00



PANO İÇİ TERMOSTATLAR

Sipariş Kodu	Ürün Kodu	Kontakt	Açıklama	Kutu Adet	Koli Adet	Fiyat TL. / AD.
7448	KTS-010	NC	Isıtma Termostatı (0 - 60°C)	1	300	120.00
7449	KTS-011	NO	Soğutma Termostatı (0 - 60°C)	1	300	120.00
7450	ZR-011	NO	Soğuk-Sıcak Termostat (0-60 C)	1	300	240.00



Çalışma Ömrü : 100.000 Açma Kapama

Ölçüler : 60x33x43

Ağırlık : 40 gr

Koruma Sınıfı : IP20



VİNÇ KUMANDA BUTONLARI PLASTİK VİNÇ KUMANDALAR (IP67)

Sipariş Kodu	Ürün Kodu	Açıklama	Kutu Adet	Koli Adet	Fiyat USD / Ad.
7501	VK - 2	Plastik Vinç Kumanda 2'li Tek Hızlı	1	72	5,80
7502	VK - 4	Plastik Vinç Kumanda 4'lü Tek Hızlı	1	48	7,50
7503	VK - 6	Plastik Vinç Kumanda 6'lı Tek Hızlı	1	42	10,00
7504	VK - 8	Plastik Vinç Kumanda 8'li Tek Hızlı	1	36	13.00



ACİL STOPLU PLASTİK VİNÇ KUMANDALAR (IP67)

Sipariş Kodu	Ürün Kodu	Açıklama	Kutu Adet	Koli Adet	Fiyat USD / Ad.
7505	VKB - 3	Plastik Vinç Kumanda 3'lü Tek Hızlı	1	50	23.00
7506	VKB - 5	Plastik Vinç Kumanda 5'li Tek Hızlı	1	40	32.00
7507	VKB - 7	Plastik Vinç Kumanda 7'li Tek Hızlı	1	30	41.00
7508	VKB - 9	Plastik Vinç Kumanda 9'lu Tek Hızlı	1	20	50.00



AYAK PEDALLARI

BİRİM FİYAT
USD/Ad.

7.85

8.00 (metal)

SİPARİŞ KODU

7601

7602

ÜRÜN KODU

JP-1

KUTU ADEDİ

1

KOLİ ADEDİ

60

AÇIKLAMA

METAL DÖKÜM ve PLASTİK PEDAL
1 mt Kablolu

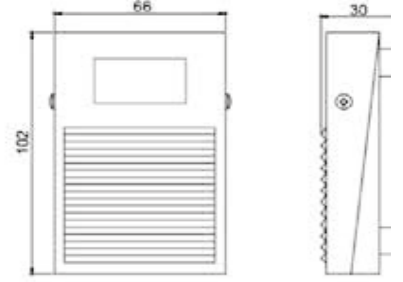

BİRİM FİYAT
USD/Ad.

11.50

SİPARİŞ KODU

7603

ÜRÜN KODU

JP-2

KUTU ADEDİ

1

KOLİ ADEDİ

60

AÇIKLAMA

ALÜMİNYUM DÖKÜM PEDAL
1 mt Kablolu

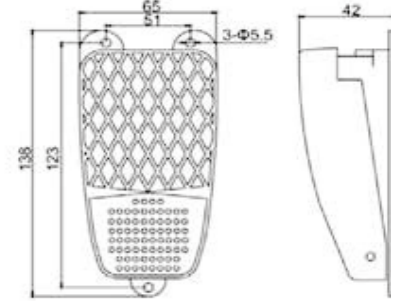

BİRİM FİYAT
USD/Ad.

14.50

SİPARİŞ KODU

7604

ÜRÜN KODU

JP-3

KUTU ADEDİ

1

KOLİ ADEDİ

40

AÇIKLAMA

ALÜMİNYUM DÖKÜM PEDAL
1 mt Kablolu

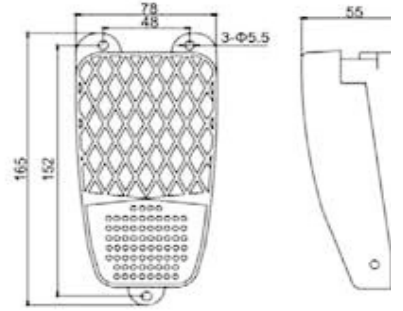

BİRİM FİYAT
USD/Ad.

37.00

SİPARİŞ KODU

7605

ÜRÜN KODU

JP-9

KUTU ADEDİ

1

KOLİ ADEDİ

12

AÇIKLAMA

METAL DÖKÜM PEDAL

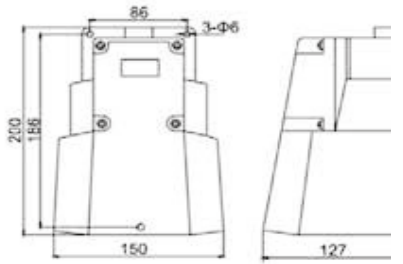

Jameson®



SWITCH FAN VE FİLTRE ÇEŞİTLERİ

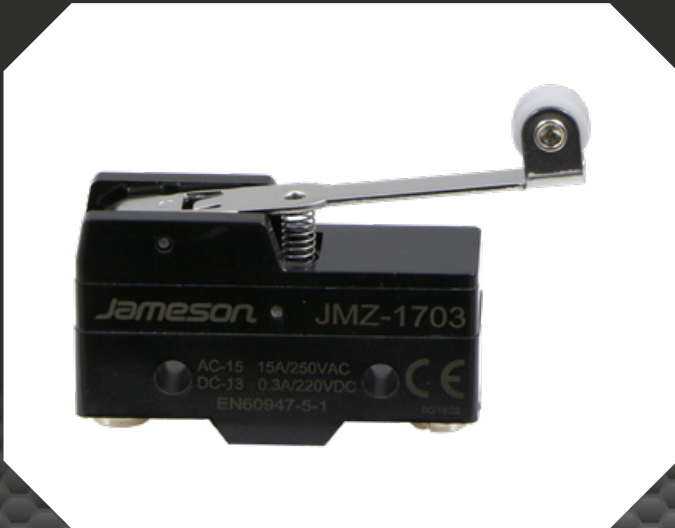

JLS SERİSİ LİMİT SWITCH

BİRİM FİYAT
USD/Ad. **6.70**

SİPARİŞ KODU 7701

ÜRÜN KODU **JLS-101**

KUTU ADEDİ 10

KOLİ ADEDİ 100

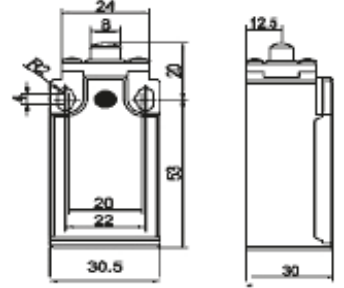
AÇIKLAMA Ayarlanabilir Metal Makaralı
Çift Yön 1NO + 1 NCBİRİM FİYAT
USD/Ad. **6.70**

SİPARİŞ KODU 7702

ÜRÜN KODU **JLS-103**

KUTU ADEDİ 10

KOLİ ADEDİ 100

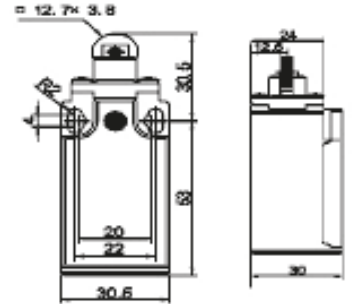
AÇIKLAMA Dikey Metal Makaralı Resetli
1NO + 1 NCBİRİM FİYAT
USD/Ad. **7.20**

SİPARİŞ KODU 7703

ÜRÜN KODU **JLS-103-R**

KUTU ADEDİ 10

KOLİ ADEDİ 100

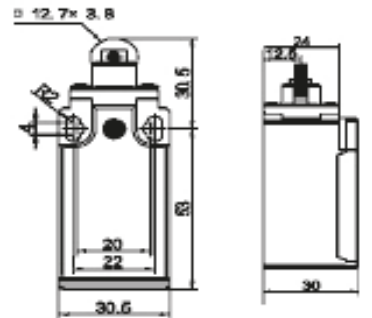
AÇIKLAMA Kısa Dikey Metal Pim
1NO + 1 NC

JLS SERİSİ LİMİT SWITCH

BİRİM FİYAT USD/Ad.	6.70
SİPARİŞ KODU	7704
ÜRÜN KODU	JLS-111
KUTU ADEDİ	10
KOLİ ADEDİ	100
AÇIKLAMA	Açısal Metal Makaralı Tek Yön 1NO + 1 NC

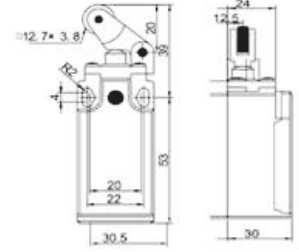

BİRİM FİYAT USD/Ad.	6.70
SİPARİŞ KODU	7705
ÜRÜN KODU	JLS-121
KUTU ADEDİ	10
KOLİ ADEDİ	100
AÇIKLAMA	Dikey Metal Makaralı Çift Yön 1NO + 1 NC

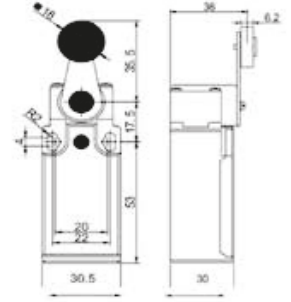

BİRİM FİYAT USD/Ad.	6.70
SİPARİŞ KODU	7706
ÜRÜN KODU	JLS-127
KUTU ADEDİ	10
KOLİ ADEDİ	100
AÇIKLAMA	Ters Açısal Metal Makaralı Tek Yön 1NO + 1 NC

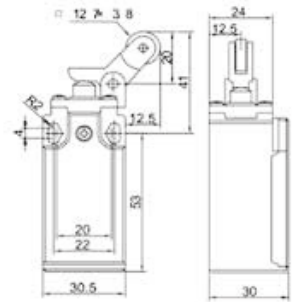

JLS SERİSİ LİMİT SWITCH

BİRİM FİYAT
USD/Ad. **7.10**

SİPARİŞ KODU 7707

ÜRÜN KODU **JLS-131**

KUTU ADEDİ 10

KOLİ ADEDİ 100

AÇIKLAMA Ayarlanabilir Metal Makaralı
Çift Yön 1NO + 1 NC

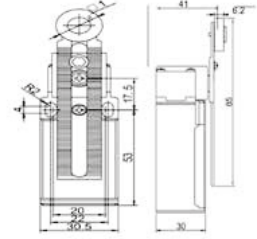

BİRİM FİYAT
USD/Ad. **7.00**

SİPARİŞ KODU 7708

ÜRÜN KODU **JLS-161**

KUTU ADEDİ 10

KOLİ ADEDİ 100

AÇIKLAMA Çok Yönlü Spiral Tel Uç
1NO + 1 NC

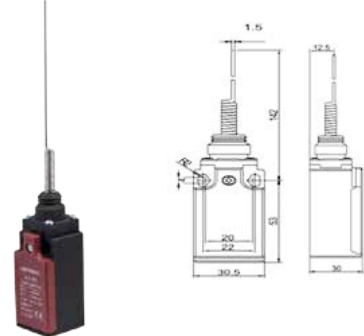

BİRİM FİYAT
USD/Ad. **7.00**

SİPARİŞ KODU 7709

ÜRÜN KODU **JLS-171**

KUTU ADEDİ 10

KOLİ ADEDİ 100

AÇIKLAMA Çok Yönlü Spiral Plastik Uç
1NO + 1 NC

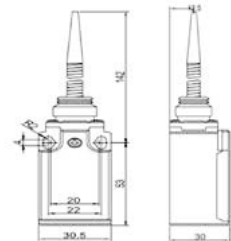

JLS SERİSİ LİMİT SWITCH

BİRİM FİYAT
USD/Ad. **7.00**

SİPARİŞ KODU 7710

ÜRÜN KODU **JLS-191**

KUTU ADEDİ 10

KOLİ ADEDİ 100

AÇIKLAMA Ayarlanabilir Kauçuk Makara
Çift Yön 1NO + 1 NC

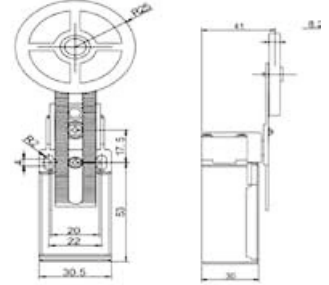

BİRİM FİYAT
USD/Ad. **8.80**

SİPARİŞ KODU 7711

ÜRÜN KODU **JLS-191-R**

KUTU ADEDİ 10

KOLİ ADEDİ 100

AÇIKLAMA Ayarlanabilir Kauçuk Makara
Çift Yön 1NO + 1 NC

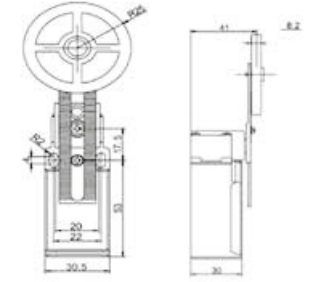

JMZ SERİSİ MİKRO SWITCH

BİRİM FİYAT USD/Ad.	3.60
SİPARİŞ KODU	7712
ÜRÜN KODU	JMZ-1300
KUTU ADEDİ	20
KOLİ ADEDİ	360
AÇIKLAMA	İnce Kısa Pimli 15A 1NO + 1 NC

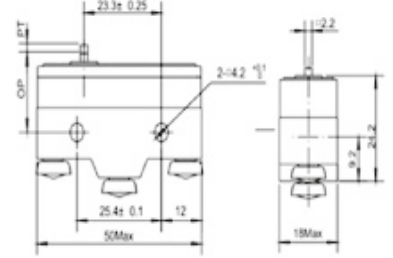

BİRİM FİYAT USD/Ad.	4.00
SİPARİŞ KODU	7713
ÜRÜN KODU	JMZ-1306
KUTU ADEDİ	20
KOLİ ADEDİ	360
AÇIKLAMA	Kalın Uzun Pimli 15A 1NO + 1 NC

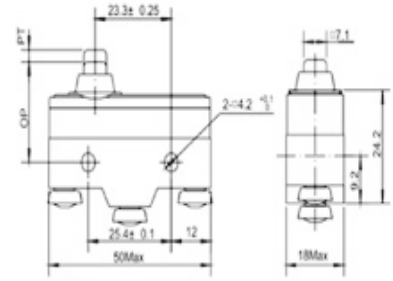

BİRİM FİYAT USD/Ad.	4.60
SİPARİŞ KODU	7714
ÜRÜN KODU	JMZ-1305
KUTU ADEDİ	20
KOLİ ADEDİ	360
AÇIKLAMA	İnce Uzun Pimli 15A 1NO + 1 NC

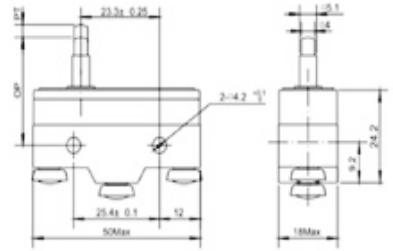

BİRİM FİYAT USD/Ad.	4.00
SİPARİŞ KODU	7715
ÜRÜN KODU	JMZ-1701
KUTU ADEDİ	20
KOLİ ADEDİ	360
AÇIKLAMA	Uzun Palet 15A 1NO + 1 NC

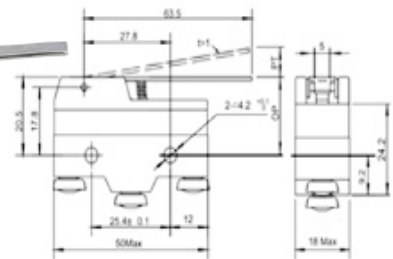

JMZ SERİSİ MİKRO SWITCH

BİRİM FİYAT
USD/Ad. **4.30**

SİPARİŞ KODU 7716

ÜRÜN KODU **JMZ-1703**

KUTU ADEDİ 20

KOLİ ADEDİ 360

AÇIKLAMA Uzun Palet Metal Makaralı
15A 1NO + 1 NC

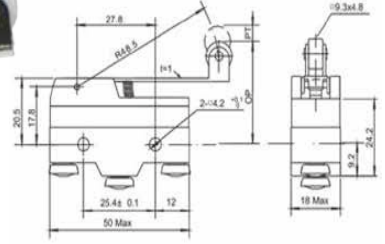

BİRİM FİYAT
USD/Ad. **4.00**

SİPARİŞ KODU 7717

ÜRÜN KODU **JMZ-1702**

KUTU ADEDİ 20

KOLİ ADEDİ 360

AÇIKLAMA Kısa Paletli 15A
1NO + 1 NC

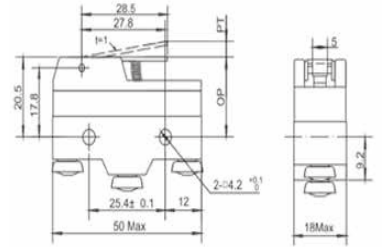

BİRİM FİYAT
USD/Ad. **4.30**

SİPARİŞ KODU 7718

ÜRÜN KODU **JMZ-1704**

KUTU ADEDİ 20

KOLİ ADEDİ 360

AÇIKLAMA Kısa Metal Makaralı 15 A 1NO
+ 1 NC

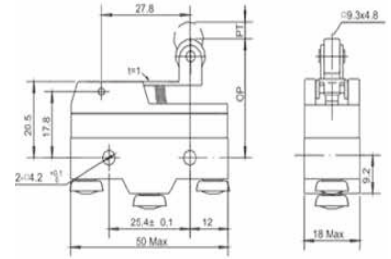

BİRİM FİYAT
USD/Ad. **4.80**

SİPARİŞ KODU 7719

ÜRÜN KODU **JMZ-1743**

KUTU ADEDİ 20

KOLİ ADEDİ 360

AÇIKLAMA Tahrikli Metal Makaralı
15A 1NO + 1 NC

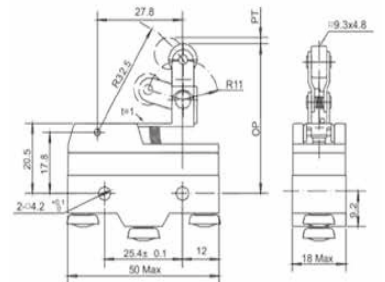

JMZ SERİSİ MİKRO SWİTÇ

BİRİM FİYAT USD/Ad.	6.00
SİPARİŞ KODU	7720
ÜRÜN KODU	JMZ-1308
KUTU ADEDİ	20
KOLİ ADEDİ	360
AÇIKLAMA	Dikey Metal Makaralı 15A 1NO + 1 NC

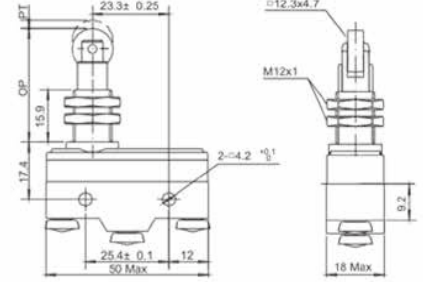

BİRİM FİYAT USD/Ad.	5.20
SİPARİŞ KODU	7721
ÜRÜN KODU	JMZ-1307
KUTU ADEDİ	20
KOLİ ADEDİ	360
AÇIKLAMA	Kalın Kısa Metal Pimli 15A 1NO + 1 NC

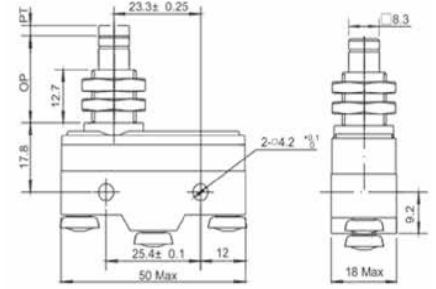

BİRİM FİYAT USD/Ad.	6.00
SİPARİŞ KODU	7722
ÜRÜN KODU	JMZ-1309
KUTU ADEDİ	20
KOLİ ADEDİ	360
AÇIKLAMA	Yan Dik Metal Makaralı 15A 1NO + 1 NC

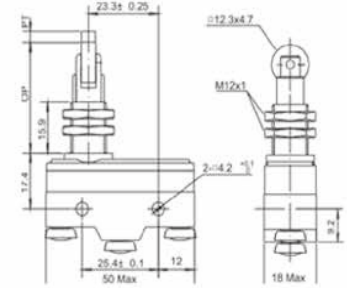

BİRİM FİYAT USD/Ad.	4.35
SİPARİŞ KODU	7723
ÜRÜN KODU	JMZ-1705
KUTU ADEDİ	20
KOLİ ADEDİ	360
AÇIKLAMA	Uzun Tel Palet 15A 1NO + 1 NC

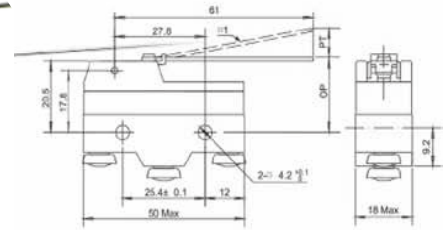

BİRİM FİYAT USD/Ad.	0.75
SİPARİŞ KODU	7724
ÜRÜN KODU	JAP-Y
KUTU ADEDİ	100
KOLİ ADEDİ	1000
AÇIKLAMA	Koruma Kabı

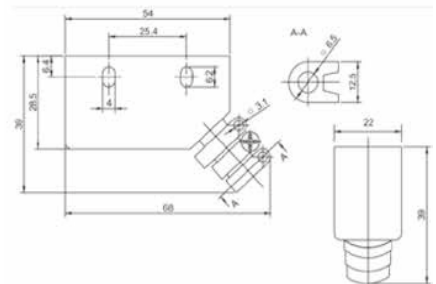

JMS SERİSİ MİKRO SWITCH

BİRİM FİYAT USD/Ad.	1.23		
SİPARİŞ KODU	7725	ÜRÜN KODU	JMS-100C
KUTU ADEDİ	100	KOLİ ADEDİ	1.800
AÇIKLAMA	100 Amper Plastik Pimli Mikro Switch		



BİRİM FİYAT USD/Ad.	1.23		
SİPARİŞ KODU	7726	ÜRÜN KODU	JMS-101C
KUTU ADEDİ	100	KOLİ ADEDİ	1.800
AÇIKLAMA	100 Amper Orta Kollu Mikro Switch		



BİRİM FİYAT USD/Ad.	1.23		
SİPARİŞ KODU	7727	ÜRÜN KODU	JMS-102C
KUTU ADEDİ	100	KOLİ ADEDİ	1.800
AÇIKLAMA	100 Amper Kısa Kollu Mikro Switch		



BİRİM FİYAT USD/Ad.	1.37		
SİPARİŞ KODU	7728	ÜRÜN KODU	JMS-103C
KUTU ADEDİ	100	KOLİ ADEDİ	1.800
AÇIKLAMA	100 Amper Uzun Kollu Metal Makaralı Mikro Switch		



BİRİM FİYAT USD/Ad.	1.37		
SİPARİŞ KODU	7729	ÜRÜN KODU	JMS-104C
KUTU ADEDİ	100	KOLİ ADEDİ	1.800
AÇIKLAMA	100 Amper Kısa Kollu Metal Makaralı Mikro Switch		



BİRİM FİYAT USD/Ad.	1.37		
SİPARİŞ KODU	7730	ÜRÜN KODU	JMS-105C
KUTU ADEDİ	100	KOLİ ADEDİ	1.800
AÇIKLAMA	100 Amper Uzun Kollu Mikro Switch		



BİRİM FİYAT USD/Ad.	1.37		
SİPARİŞ KODU	7731	ÜRÜN KODU	JMS-106C
KUTU ADEDİ	100	KOLİ ADEDİ	1.800
AÇIKLAMA	100 Amper Kıvrık Kollu Mikro Switch		



FANLAR

ÜRÜN KODU	KUTU ADET	Birim Fiyat USD.
JF-8025-24V	50	6.75
JF-8025-220V	50	9.00
JF-12025-24V	40	6.00
JF-12025-220V	40	11.25
JF-17050-24V	25	42.00
JF-17050-220V	25	27.00
JF-22580-220V	10	109.5



FAN FİLTRELERİ

ÜRÜN KODU	KUTU ADET	Birim Fiyat USD.
JF-107F	120	6.00
JF-148F	60	6.15
JF-205F	40	8.25
JF-255F	30	22.50



FAN KORUMA TELLERİ

ÜRÜN KODU	KUTU ADET	Birim Fiyat USD.
JF-80M	500	1.02
JF-120M	200	1.08
JF-170M	100	1.5
JF-225M	50	12.75

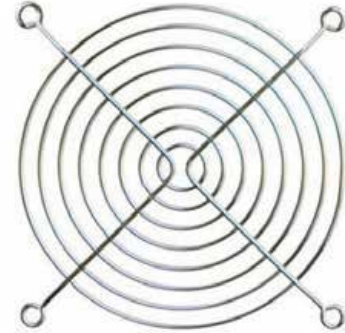

JAMESON®



Kivilcim Elektrik

Merkez
Zeki Ayan Mah.
Mezarlık Caddesi No: 73 / A
Toroslar / MERSİN

Şube
Mahmutbey Mah. İstoç Ticaret Merkezi
2454. Sk. 34. Ada No: 20
Bağcılar / İSTANBUL

Tel: 0324 324 20 10

Whatsapp Sipariş Hattı:
0531 727 74 64 

www.kivilmielektrik.com.tr